













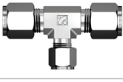

























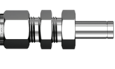













# Tube Fittings (Standard Superlok)



# INDEX

UNION			TEE			O-RING SEAL		
	<b>SU</b> Union	10		<b>SUT</b> Union Tee	32		<b>SOSC</b> O-Seal Straight Thread Connector	50
	<b>SRU</b> Reducing Union	11		<b>SRUT</b> Reducing Union Tee	33		<b>SOPC</b> O-Seal Pipe Thread Connector	50
	<b>SBHRU</b> Bulkhead Reducing Union	12		<b>SMBT</b> Male Branch Tee	34		<b>SSMC</b> SAE/MS Male Connector	51
	<b>SBHU</b> Bulkhead Union	13		<b>SPMBT</b> Positionable Male Branch Tee	35	<b>WELD END</b>		
<b>CONNECTOR</b>				<b>SMRT</b> Male Run Tee	36		<b>SPWC</b> Male Pipe Weld Connector	55
	<b>SMC</b> Male Connector	14		<b>SPMRT</b> Positionable Male Run Tee	37		<b>SMPWE</b> Male Pipe Weld Elbow	56
	<b>SMC-GM</b> Male Connector for Metal Gasket Seal	18		<b>SFBT</b> Female Branch Tee	38		<b>SSWC</b> Tube Socket Weld Connector	56
	<b>SGMC</b> Male Connector for Bonded Washer Seal	19		<b>SFRT</b> Female Run Tee	39		<b>SSWE</b> Tube Socket Weld Elbow	56
	<b>SFC</b> Female Connector	20		<b>SUC</b> Union Cross	40	<b>PLUG &amp; CAP</b>		
	<b>SGC</b> Gauge Connector	22	<b>STUB TUBE CONNECTOR</b>				<b>SP</b> Plug	57
	<b>SMCB</b> Bulkhead Male Connector	23		<b>SR</b> Reducer	41		<b>SC</b> Cap	57
	<b>SFCB</b> Bulkhead Female Connector	23		<b>SRB</b> Bulkhead Reducer	43	<b>SPARE PART</b>		
<b>ELBOWS</b>				<b>SMA</b> Male Adapter	44		<b>SN</b> Nut	58
	<b>SUE</b> Union Elbow	24		<b>SFA</b> Female Adapter	44		<b>SFF</b> Front Ferrule	58
	<b>SME</b> Male Elbow	25		<b>SPC</b> Port Connector	46		<b>SBF</b> Back Ferrule	59
	<b>SHME</b> 45° Male Elbow	28		<b>SRPC</b> Reducing Port Connector	47		<b>SFS</b> Ferrule Set	59
	<b>SPHME</b> 45° Positionable Male Elbow	29		<b>SFTC</b> Flange Lapped Tubes Connector	48	<b>AN TUBE</b>		
	<b>SPME</b> Positionable Male Elbow	29		<b>SAF</b> An Flare	48		<b>SI</b> Insert	59
	<b>SFE</b> Female Elbow	31		<b>SAU</b> An Union	49		<b>SBHR</b> Bulkhead Retainer	60
				<b>SAA</b> An Adapter	49		<b>SVP</b> Vent Protector	60

# Features of Superlok Tube Fittings



Superlok Tube Fittings are produced under strict quality control using the highest quality raw materials. Positive material identification (PMI), rigorous testing and quality assurance procedures are the foundation of the Superlok brand.

Superlok Tube Fittings tighten easily and are leak free under shock, vibration and temperature cycling. Superlok fittings feature exceptional internal surface finish which reduces particle entrapment, potential contamination and improves the flow of liquids and gases.

Superlok Instrumentation Valves and Fittings are specified across many global markets including Automotive, Aerospace, Semiconductor, Shipbuilding and Petrochemical industries.

## Structure of Superlok Tube Fittings

Superlok consists of 4 precision parts:

- Body
- Front Ferrule
- Rear Ferrule
- Nut

All parts are manufactured to very strict tolerances under tight quality control measures. The result is a highly reliable product that is suitable for demanding conditions across all industrial markets.

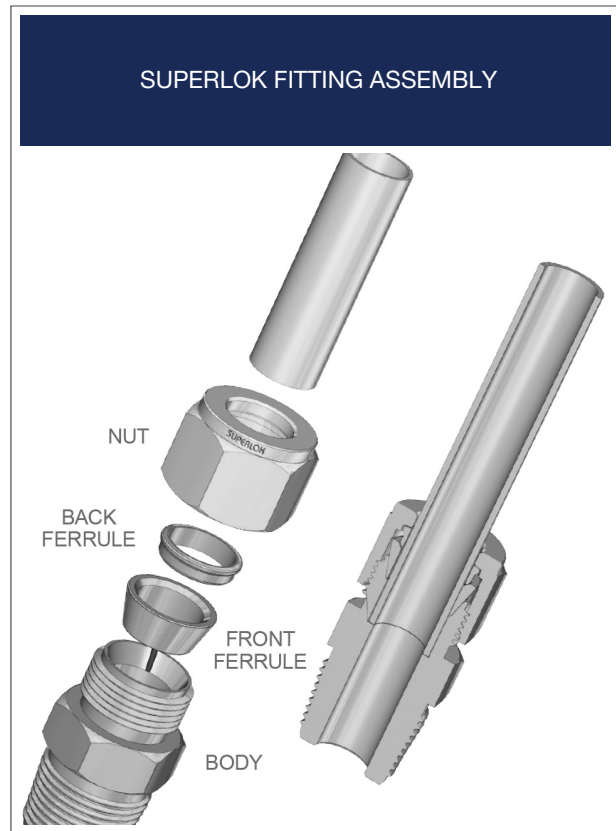



## Superlok Installation Instructions

### Installation under 1 inch or 25 mm:

Superlok Tube Fittings shall be delivered to the customer in a completely assembled state, ready for immediate use. Disassembling the product before installation is not recommended as doing so can result in contamination which can cause leaks.

Superlok Tube Fittings are installed in three easy steps:

#### Step 1

Insert the tubing into Superlok Tube Fitting. At this point, make sure that the tubing is in contact with the internal shoulder of fitting and then finger-tighten the nut.

#### Step 2

Before tightening the Superlok nut, mark the starting point at the 6 o'clock position.

#### Step 3

While holding the fitting body with a wrench, tighten the nut 1-1/4 turns to the 9 o'clock position for sizes 1/4" to 1". For 1/16", 1/8", and 3/16" tighten the nut three quarters turn to the 3 o'clock position. Ensure fitting is properly made using a superlok Gap Inspection Gauge.

#### Gaugeability

On initial installation, the Superlok Inspection Gauge assures the installer or inspector that a fitting has been sufficiently tightened.

Position the Superlok Inspection Gauge next to the gap between the nut and the body.

- If the gauge will not enter the gap, the fitting is sufficiently tightened.



- If the gauge will enter the gap, additional tightening is required.

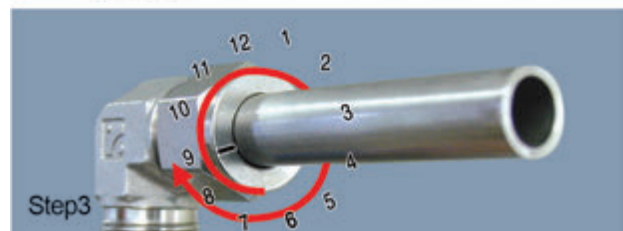
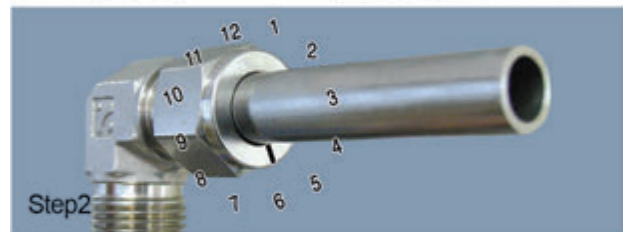

### Installation for high pressure or severe service systems:

Since tubing has different O.D. tolerance, it is important to have a common starting point to take out in dimensional variations. This is done by tightening the fitting slightly until the tubing can not freely rotate in the fitting as it can in the finger-tight position. At this point tighten the nut 1-1/4 turns.

### Safety Considerations on Installations for High Pressure Systems

1. Make sure the proper tubing wall thickness is selected in accordance with pressure ratings. Tubing should have a hardness of HRB 80 or less.
2. Do not assemble or disassemble fittings when the system is pressurized.

### Re-tightening Instructions:

#### Step 1

Pic. 1 shows the fitting in the disconnected position. Insert the tubing with the pre-swaged ferrules into the fitting body making sure the front ferrule is firmly seated as shown in Pic 2.

#### Step 2

Finger tighten the nut and then with a wrench turn the nut to the original 9 o'clock position. At this point a change of resistance will be felt. Tighten the nut slightly more and the installation is complete as shown in Pic 3.

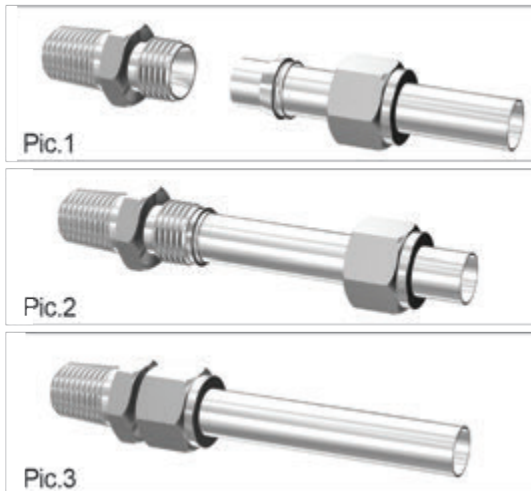

## Technical Information

### Hardness Limitation

Use only high quality stainless steel tubing that is fully annealed. Seamless tubing or welded per ASTM A269, A213 or equivalent should be used with Superlok Tube

Fittings. The tubing must be a maximum hardness of HRB 90 on the Rockwell Scale, however, HRB 80 is more suitable for bending and results in easier fitting make-up.

### Compatibility/Warranty

Superlok Tube Fittings are manufactured to be 100% interchangeable with comparable tube fittings on the market. Superlok fully warrants fittings interchanged with Superlok components per the standard Superlok warranty. Consult Superlok Canada for further details.

### Gas System Application

Superlok Tube Fittings are suitable for gas systems. The recommended “best practice” standards below should be followed:

1. Tubing hardness must be less than that of the ferrules.
2. Tubing should be free of surface imperfections and deformation.
3. Refer to table for selection of the appropriate wall thickness (only shaded areas should be selected for gas systems).
4. Tubing ends must be cut squarely and perpendicular to the center-line of the tubing. After the tubing is cut, it must be deburred on both the inside and outside with a high quality fully sharpened deburring tool.
5. Follow the Superlok installation instructions in the catalog.
6. Do not attempt to bend the tubing after a fitting has been installed in a fixed position.
7. Tubing systems should be installed to allow for adequate expansion and contraction as well as ease of maintenance.

Material	Bar Stock	Forging
316 SS	ASTM A479 ASTM A276	ASTM A182
Monel, Alloy 400	ASTM B164	ASTM B 564
Inconel, Alloy 600	ASTM B 166	ASTM B 564
Hastelloy, Alloy C-276	ASTM B 574	ASTM B 564
Brass	ASTM B 16 ASTM B 453	ASTM B 283

Superlok Tube Fittings are available standard in stainless steel, brass, and alloy materials. Straight fittings are machined from cold finished bar stock and shaped bodies from forgings. Specifications for fitting materials are listed below. For special applications, contact Superlok Canada.

## Maximum Temperature by Materials

Aluminum	400 °F	204 °C
Copper	400 °F	204 °C
Steel	375 °F	191 °C
SUS304	1000 °F	538 °C
SUS316	1200 °F	649 °C
MONEL	800 °F	427 °C

Please refer to ASME B31.3-1993 for detailed information about the maximum and minimum temperature of various materials.

## Vacuum, Cryogenic and High Temperature Applications

Superlok Tube Fittings have been tested in vacuum, cryogenic and high temperatures ensuring consistent and reliable performance in the most severe applications.

## Threads

### 1. NPT (National Pipe Thread)

- Thread angle 60°
- Tapered angle 1°47'
- Manufactured by the standard of ASME B 1.20.1

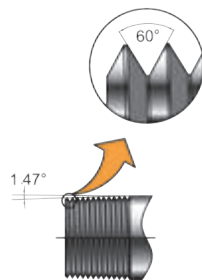

### 2. ISO 7/1 Tapered Thread

- Thread angle 55°
- Tapered angle 1°47'
- Equivalent to the standard of DIN2999, BS21 (BSPT) and JIS B0203 (PT).

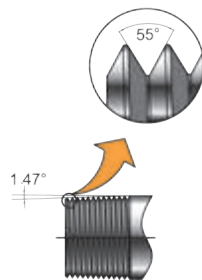

### 3. ISO 228/1 Parallel Thread

- Thread angle 55°
- Equivalent to the standard of BS 2779 (BSPP), JIS B0202 (PF).
- In lieu of thread sealant, straight threads are sealed with the use of a mechanical gasket design such as the following:

- Use a gasket or o-ring to seal.

#### a) Bonded Washer

A self centering taper is used at the hex which centers a composite washer (typically metal/elastomer) to seal the surface surrounding the female thread.

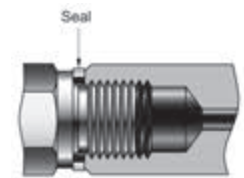

#### b) Metal Gasket Seal

A metal gasket (typically copper) is centered between the two mating surfaces in order to create a seal.

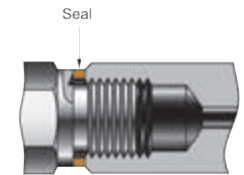

#### c) Metal Gasket

A gasket is inserted between the face of the male thread and the bottom shoulder of the female thread. A seal is created as the threads are tightened and force is applied to the gasket between the two mating surfaces.

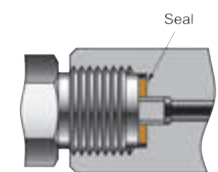

## 4. UNF Thread

- Thread angle 60°
- This is classified into UN, UNC and UNF. The standard is classified by the diameter of thread and the number of threads per inch.
- ASME B 1.1

## Tube Standard Information

### Tube Selection

Suitable tube selection is essential in performance of tubing system. When selecting tubing material, size and wall thickness, the installer must consider pressure, flux (flow), temperature, environment and compatibility of materials to system media.

#### Considerations in selecting tube:

1. Quality of the tube materials and manufacturing method.
2. Thickness and outer diameter of tube.
3. Surface treatment of tube.
4. Hardness of tube.
5. Concentricity of tube.
6. Pressure coefficient as it relates to temperature change (see Table 2 below).

## Tube Fabrication

It is important to ensure there is a sufficient length of straight tubing between the fitting and the first bend. This ensures proper connections and prevents leakage. Tube surface before and after fabrication must be free of surface damage or imperfections.

**The minimum recommended straight length of tubing between the fitting and a bend:**

**Table 1**

Tube O.D. (in)	1/8	3/16	1/4	5/16	3/8	1/2	5/8	3/4	7/8	1
L (in)	0.50	0.72	0.75	0.81	0.87	0.94	1.18	1.25	1.31	1.5

L = the distance from the the tube shoulder in the fitting body to the start of the bend.

## Recommended Tube Specifications:

### Carbon Steel Tubing

- ASTM A179 or equivalent.
- Carbon steel tubing for an oil pressure usage of high quality, annealed and seamless.
- Maximum hardness: HRB72.
- Tubing must be free from scars and suitable for bending and expansion works.

### Copper Tubing

- ASTM B68, B75 or equivalent.
- Copper tubing of high quality, annealed and seamless.

### Stainless Steel Tubing

- ASTM A213, A269 or equivalent.
- Stainless steel tubing of high quality, annealed and seamless. (316, 304, 321, etc.)
- Hardness: HRB90 or less. HRB80 or less is recommended.
- Tubing must be free from scars and shall be suitable for bending and system expansion.

### Monel Tubing

- ASTM B165 or equivalent.
- 400 alloy tubing of high quality, annealed and seamless
- Hardness: below HRB 75.
- Tubing must be free from scars and shall be suitable for bending and system expansion.

## Pressure Grade Coefficient of Tubing due to Temperature Change:

**Table 2**

°F	°C	Copper	304SS	316SS	Monel
200	93	0.80	1.00	1.00	0.88
400	204	0.50	0.93	0.96	0.79
600	316	---	0.82	0.85	0.79
800	427	---	0.76	0.79	0.76
1000	538	---	0.69	0.76	---
1200	649	---	0.30	0.37	---

Multiply the allowable working pressure in Table 2 by the coefficient in Table 3 in order to determine allowable pressure at high temperature.

### Example

SUS316  
(3/8" O.D of tube) X (0.049" wall thickness)  
1200°F : 4800 psi X 0.37 = 1776 psi

The applicable operation pressure of SUS316 tubing for wall thickness, 3/8" O.D x 0.049", is 1776 psi at 1200°F

## Technical Data

**Table 3 - Stainless Steel Tube Working Pressure Table**

Use stainless steel tubing which is high quality (such as 304, 316, 316L, etc.), fully annealed and seamless ASTM A269, A213 or equivalent.

### STAINLESS STEEL FRACTION TUBE

Tube O.D. (inch)	TUBE WALL THICKNESS (inch)												
	0.010	0.012	0.014	0.016	0.020	0.028	0.035	0.049	0.065	0.083	0.095	0.109	0.120
1/16	5600	6800	8100	9400	12000								
1/8						8500	10900						
3/16						5400	7000	10200					
1/4						4000	5100	7500	10200				
5/16							4000	5800	8000				
3/8							3300	4800	6500				
1/2							2600	3700	5100	6700			
5/8								2900	4000	5200	6000		
3/4								2400	3300	4200	4900	5800	
7/8								2000	2800	3600	4200	4800	
1									2400	3100	3600	4200	4700

\* Tubing working pressure(ksi)

### STAINLESS STEEL METRIC TUBE

Tube O.D. (mm)	TUBE WALL THICKNESS (mm)												
	0.71	0.89	1.00	1.25	1.50	1.65	2.00	2.11	2.41	2.50	2.77	3.00	3.05
3	10800	13800	15300										
4	7900	10100	11500	14400									
6	5000	6500	7400	9400	11500	12700							
8		4700	5800	6800	8400	9300							
10		3700	4200	5300	6500	7300							
12		3000	3400	4400	5300	5900	6800	7200					
16			2500	3200	3900	4300	5300	5700	6600	6800			
18				2800	3400	3800	4700	5000	5800	6000	6700		
20				2500	3000	3400	4200	4400	5100	5300	6000		
22				2300	2800	3000	3800	4000	4600	4800	5400		
25				2000	2400	2700	3300	3500	4000	4200	4700	5100	5200

\* Tubing working pressure(ksi)

Allowable stress value between -20°F and 100°F (-28.9°C ~ 37.8°C) is 19,500 psi  
Safety factor is 4 (ultimate tensile strength is 75,000 psi)

- The above data is based on the minimum wall thickness and the maximum O.D. allowed by and under the ASTM A269 Standard.
- The data above does not account for the effects of corrosion or erosion of the tubing.



# Single Ferrule Tube Fittings

Available in sizes from 1/16" to 1" in.

## Features:

- Fewer parts, simpler design.
- Fewer seal points, fewer leak paths.
- Greater resistance to vibration.
- "Spring-Loaded" ferrule design for superior performance in thermal cycling.
- 25% less torque versus other designs.



## Single Ferrule Design:

Superlok Canada offers both Double and Single Ferrule tube fittings. While the Double Ferrule design is more common, there are situations where Single Ferrule tube fittings are preferred. Superlok Single and Double Ferrule systems are fully interchangeable and provide high performance, leak-free connections. The Single Ferrule is specifically designed to withstand excessive vibration, high pressure cycling and is ideal for vacuum service.

## Ordering Information:

The Single Ferrule tube fittings part numbering system is the same as our Superlok Tube Fitting, with the exception that you add an "S" as a suffix to tube size.

Example

**SMC** - **8S** - **8N** - **SS**  
 1                    2-1                    2-2                    3

### 1. Type of Fitting

- Referred to in the Superlok Tube Fitting catalog INDEX.  
 Examples : SMC (male connector), SU (union),  
 SME (male elbow), SUT (union tee)...

### 3. Material

- SS : 316 stainless steel
- B : Brass

### 2. Size of Fitting

#### 2-1) Tube O.D. Designation

2-1) Tube O.D.(inch)	1/4	3/8	1/2	3/4	1
Designation	4S	6S	8S	12S	16S

#### 2-2) Pipe Thread Designation

2-2) Size(inch)	1/8	1/4	3/8	1/2	3/4	1
ISO Tapered	2R	4R	6R	8R	12R	16R
Screwed NPT	2N	4N	6N	8N	12N	16N
ISO	2G	4G	6G	8G	12G	16G
Unified Screw	2U	4U	6U	8U	12U	16U

# SU Union

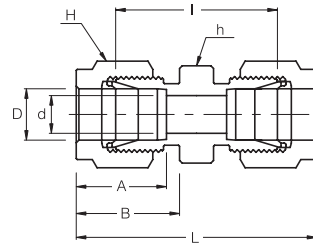

## Connects Fractional Tubes

Part No.	Tube O.D. D (inch)	d Min	Width Across Flat		A	B	I	L
			h (inch)	H (inch)				
SU - 1	1/16	1.27	5/16	5/16	8.63	10.92	17.52	25.15
SU - 2	1/8	2.28	7/16	7/16	12.70	15.24	22.35	35.56
SU - 3	3/16	3.04	7/16	1/2	13.71	16.00	24.13	37.33
SU - 4	1/4	4.82	1/2	9/16	15.24	17.78	26.16	40.89
SU - 5	5/16	6.35	9/16	5/8	16.25	18.54	28.19	42.92
SU - 6	3/8	7.11	5/8	11/16	16.76	19.30	30.22	44.95
SU - 8	1/2	10.41	13/16	7/8	22.86	21.84	30.98	51.30
SU - 10	5/8	12.70	15/16	1	24.38	21.84	31.75	52.07
SU - 12	3/4	15.74	1-1/16	1-1/8	24.38	21.84	33.27	53.59
SU - 14	7/8	18.28	1-3/16	1-1/4	25.90	21.84	34.79	55.11
SU - 16	1	22.35	1-3/8	1-1/2	31.24	26.41	40.38	64.77
SU - 20	1-1/4	27.69	1-3/4	1-7/8	41.15	38.86	48.00	92.20
SU - 24	1-1/2	34.04	2-1/8	2-1/4	50.04	45.21	53.59	107.95
SU - 32	2	45.97	2-3/4	3	67.56	62.74	74.68	149.35

## Connects Metric Tubes

Part No.	Tube O.D. D	d Min	Width Across Flat		A	B	I	L
			h	H				
SU - 2M	2	1.7	12	12	12.9	15.3	22.4	35.6
SU - 3M	3	2.4	12	12	12.9	15.3	22.1	35.3
SU - 4M	4	2.4	12	12	13.7	16.1	24.1	37.3
SU - 6M	6	4.8	14	14	15.3	17.7	26.2	41.0
SU - 8M	8	6.4	15	16	16.2	18.6	28.2	43.2
SU - 10M	10	7.9	18	19	17.2	19.5	31.0	46.2
SU - 12M	12	9.5	22	22	22.8	22.0	31.0	51.2
SU - 15M	15	11.9	24	25	24.4	22.0	31.8	52.0
SU - 16M	16	12.7	24	25	24.4	22.0	31.8	52.0
SU - 18M	18	15.1	27	30	24.4	22.0	33.3	53.5
SU - 20M	20	15.9	30	32	26.0	22.0	34.8	55.0
SU - 22M	22	18.3	30	32	26.0	22.0	34.8	55.0
SU - 25M	25	21.8	35	38	31.3	26.5	40.4	65.0

\*All dimensions in millimeters unless specified as "inch". Dimension are for reference only, subject to change

# SRU

## Reducing Union

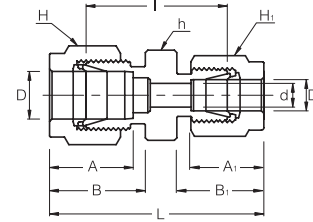

### Connects Fractional Tubes

Part No.	Tube O.D.		d Min	Width Across Flat			A	A <sub>1</sub>	B	B <sub>1</sub>	I	L
	D (inch)	D <sub>1</sub> (inch)		h (inch)	H (inch)	H <sub>1</sub> (inch)						
SRU - 2 - 1	1/8	1/16	1.27	7/16	7/16	5/16	12.7	8.63	15.24	10.92	20.60	31.00
SRU - 3 - 2	3/16	1/8	2.28	7/16	1/2	7/16	13.71	12.70	16.00	15.24	23.36	36.57
SRU - 4 - 2	1/4	1/8	2.28	1/2	9/16	7/16	15.24	12.70	17.78	15.24	24.63	38.60
SRU - 4 - 3	1/4	3/16	3.04	1/2	9/16	1/2	15.24	13.71	17.78	16.00	25.40	39.37
SRU - 5 - 2	5/16	1/8	2.28	9/16	5/8	7/16	16.25	12.70	18.54	15.24	25.90	39.87
SRU - 5 - 4	5/16	1/4	4.82	9/16	5/8	9/16	16.25	15.24	18.54	17.78	27.43	42.16
SRU - 6 - 2	3/8	1/8	2.28	5/8	11/16	7/16	16.76	12.70	19.30	15.24	26.92	40.89
SRU - 6 - 4	3/8	1/4	4.82	5/8	11/16	9/16	16.76	15.24	19.30	17.78	28.44	43.18
SRU - 6 - 5	3/8	5/16	6.35	5/8	11/16	5/8	16.76	16.25	19.30	18.54	29.46	44.19
SRU - 8 - 2	1/2	1/8	2.28	13/16	7/8	7/16	22.86	12.70	21.84	15.24	28.44	45.21
SRU - 8 - 4	1/2	1/4	4.82	13/16	7/8	9/16	22.86	15.24	21.84	17.78	29.46	46.99
SRU - 8 - 6	1/2	3/8	7.11	13/16	7/8	11/16	22.86	16.76	21.84	19.30	30.98	48.51
SRU -10 - 6	5/8	3/8	7.11	15/16	1	11/16	24.38	16.76	21.84	19.30	31.75	49.27
SRU -10 - 8	5/8	1/2	10.41	15/16	1	7/8	24.38	22.86	21.84	21.84	31.75	52.07
SRU -12 - 4	3/4	1/4	4.82	1-1/16	1-1/8	9/16	24.38	15.24	21.84	17.78	31.75	49.27
SRU -12 - 6	3/4	3/8	7.11	1-1/16	1-1/8	11/16	24.38	16.76	21.84	19.30	33.27	50.80
SRU -12 - 8	3/4	1/2	10.41	1-1/16	1-1/8	7/8	24.38	22.86	21.84	21.84	33.27	53.59
SRU -12 -10	3/4	5/8	12.70	1-1/16	1-1/8	1	24.38	24.38	21.84	21.84	33.27	53.59
SRU -16 - 8	1	1/2	10.41	1-3/8	1-1/2	7/8	31.24	22.86	26.41	21.84	39.50	63.24
SRU -16 -12	1	3/4	15.74	1-3/8	1-1/2	1-1/8	31.24	24.38	26.41	21.84	39.00	62.73

### Connects Metric Tubes

Part No.	Tube O.D.		d Min	Width Across Flat			A	A <sub>1</sub>	B	B <sub>1</sub>	I	L
	D	D <sub>1</sub>		h	H	H <sub>1</sub>						
SRU - 6M - 3M	6	3	2.4	14	14	12	15.3	12.9	17.7	15.3	24.6	38.6
SRU - 6M - 4M	6	4	2.4	14	14	12	15.3	13.7	17.7	16.1	25.4	39.4
SRU - 8M - 6M	8	6	4.8	15	16	14	16.2	15.3	18.6	17.7	27.4	42.3
SRU - 10M - 6M	10	6	4.8	18	19	14	17.2	15.3	19.5	17.7	29.5	44.5
SRU - 10M - 8M	10	8	6.4	18	19	16	17.2	16.2	19.5	18.6	30.0	45.1
SRU - 12M - 6M	12	6	4.8	22	22	14	22.8	15.3	22.0	17.7	29.5	47.0
SRU - 12M - 8M	12	8	6.4	22	22	16	22.8	16.2	22.0	18.6	30.2	47.8
SRU - 12M - 10M	12	10	7.9	22	22	19	22.8	17.2	22.0	19.5	31.0	48.7
SRU - 16M - 12M	16	12	9.5	24	25	22	24.4	22.8	22.0	22.0	31.8	52.0
SRU - 25M - 18M	25	18	15.1	35	38	30	31.3	24.4	26.5	22.0	38.6	61.0
SRU - 25M - 20M	25	20	15.9	35	38	32	31.3	26.0	26.5	22.0	39.9	62.3

\* All dimensions in millimeters unless specified as "inch". Dimension are for reference only, subject to change

## SRU

### Reducing Union

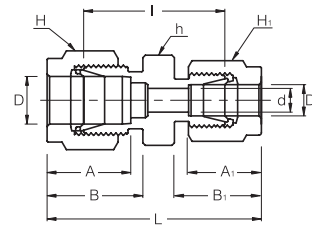

#### Connects Fractional Tubes To Metric Tubes

Part No.	Tube O.D.		d Min	Width Across Flat			A	A <sub>1</sub>	B	B <sub>1</sub>	I	L
	D <sub>1</sub> (inch)	D		h	H	H						
SRU - 2 - 3M	1/8	3	2.4	12	12	11.1	12.9	12.8	15.3	15.2	22.1	35.2
SRU - 2 - 4M	1/8	4	2.4	12	12	11.1	13.7	12.8	16.1	15.2	23.4	36.5
SRU - 4 - 4M	1/4	4	2.4	14	12	14.3	13.7	15.3	16.1	17.7	25.4	39.4
SRU - 2 - 6M	1/8	6	2.4	14	14	11.1	15.3	12.8	17.7	15.2	24.6	38.5
SRU - 4 - 6M	1/4	6	4.8	14	14	14.3	15.3	15.3	17.7	17.7	26.2	41.0
SRU - 5 - 6M	5/16	6	4.8	14	14	15.9	15.3	16.2	17.7	18.6	27.4	42.3
SRU - 4 - 8M	1/4	8	4.8	15	16	14.3	16.2	15.3	18.6	17.7	27.4	42.3
SRU - 2 - 10M	1/8	10	2.4	18	19	11.1	17.2	12.8	19.5	15.2	27.7	41.8
SRU - 4 - 10M	1/4	10	4.8	18	19	14.3	17.2	15.3	19.5	17.7	29.5	44.5
SRU - 5 - 10M	5/16	10	6.4	18	19	15.9	17.2	16.2	19.5	18.6	30.0	45.1
SRU - 6 - 10M	3/8	10	7.1	18	19	17.5	17.2	16.9	19.5	19.2	31.0	45.9
SRU - 5 - 12M	5/16	12	6.4	22	22	15.9	22.8	16.2	22.0	18.6	30.2	47.8
SRU - 6 - 12M	3/8	12	7.1	22	22	17.5	22.8	16.9	22.0	19.2	31.0	48.4
SRU - 8 - 12M	1/2	12	9.5	22	22	22.2	22.8	22.8	22.0	22.0	31.0	51.2
SRU - 8 - 15M	1/2	15	10.3	24	25	22.2	24.4	22.8	22.0	22.0	31.8	52.0
SRU - 10 - 16M	5/8	16	12.7	24	25	25.4	24.4	24.4	22.0	22.0	31.8	52.0
SRU - 12 - 18M	3/4	18	15.1	27	30	28.6	24.4	24.4	22.0	22.0	33.3	53.5
SRU - 12 - 20M	3/4	20	15.9	30	32	28.6	26.0	24.4	22.0	22.0	34.8	54.9
SRU - 16 - 20M	1	20	15.9	35	32	38.1	26.0	31.2	22.0	26.4	40.4	62.8
SRU - 16 - 25M	1	25	21.8	35	38	38.1	31.3	31.3	26.5	26.5	40.4	65.0

## SBHRU

### Bulkhead Reducing Union

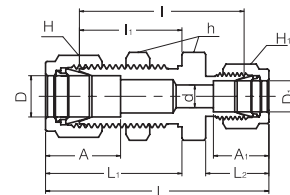

#### Connects Fractional Tubes

Part No.	Tube O.D.		d Min	Width Across Flat			A	A <sub>1</sub>	I	I <sub>1</sub>	L	L <sub>1</sub>	L <sub>2</sub>	Panel Hole Drill Size	Panel Max. Thickness
	D (inch)	D <sub>1</sub> (inch)		h (inch)	H (inch)	H <sub>1</sub> (inch)									
SBHRU - 4 - 2	1/4	1/8	2.28	5/8	9/16	7/16	15.24	12.70	41.14	26.16	55.11	33.52	15.24	11.50	10.16
SBHRU - 6 - 4	3/8	1/4	4.82	3/4	11/16	9/16	16.76	15.24	45.97	29.46	60.70	36.57	17.78	14.68	11.17
SBHRU - 8 - 4	1/2	1/4	4.82	15/16	7/8	9/16	22.86	15.24	49.27	31.75	66.80	41.91	17.78	19.44	12.70

\* All dimensions in millimeters unless specified as "inch". Dimension are for reference only, subject to change



# SBHU

## Bulkhead Union

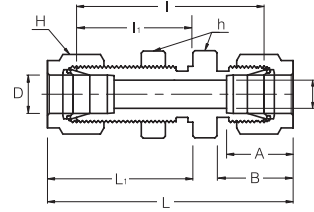

### Connects Fractional Tubes

Part No.	Tube O.D. D (inch)	d Min	Width Across Flat		A	B	I	I <sub>1</sub>	L	L <sub>1</sub>	Panel Hole Drill Size	Panel Max. Thickness
			h (inch)	H (inch)								
SBHU - 1	1/16	1.27	5/16	5/16	8.63	10.92	23.87	13.46	31.50	17.27	5.16	3.05
SBHU - 2	1/8	2.28	1/2	7/16	12.70	15.24	38.10	24.63	51.30	31.24	8.33	12.70
SBHU - 3	3/16	3.04	9/16	1/2	13.71	16.00	40.38	25.40	53.59	32.00	9.92	12.70
SBHU - 4	1/4	4.82	5/8	9/16	15.24	17.78	42.92	26.16	57.65	33.52	11.50	10.16
SBHU - 5	5/16	6.35	11/16	5/8	16.25	18.54	45.97	28.44	60.70	35.81	13.09	11.17
SBHU - 6	3/8	7.11	3/4	11/16	16.76	19.30	47.49	29.46	62.23	36.83	14.68	11.17
SBHU - 8	1/2	10.41	15/16	7/8	22.86	21.84	50.80	31.75	71.12	41.91	19.44	12.70
SBHU - 10	5/8	12.70	1-1/16	1	24.38	21.84	52.32	32.51	72.64	42.67	22.62	12.70
SBHU - 12	3/4	15.74	1-3/16	1-1/8	24.38	21.84	58.67	37.33	78.99	47.49	25.79	16.76
SBHU - 14	7/8	18.28	1-3/8	1-1/4	25.90	21.84	64.26	42.92	84.58	53.08	28.97	19.05
SBHU - 16	1	22.35	1-5/8	1-1/2	31.24	26.41	71.37	45.21	95.75	57.40	33.73	19.05

### Connects Metric Tubes

Part No.	Tube O.D. D	d Min	Width Across Flat			A	B	I	I <sub>1</sub>	L	L <sub>1</sub>	Panel Hole Drill Size	Panel Max. Thickness
			h	h <sub>1</sub> *	H								
SBHU - 3M	3	2.4	14	12.7	12	12.9	15.3	38.1	24.6	51.3	31.2	8.3	12.7
SBHU - 4M	4	2.4	14	14.3	12	13.7	16.1	40.4	25.4	53.6	32.0	9.9	12.7
SBHU - 6M	6	4.8	16	15.9	14	15.3	17.7	42.9	26.2	57.7	33.6	11.5	10.2
SBHU - 8M	8	6.4	18	17.5	16	16.2	18.6	46.0	28.6	61.0	36.1	13.1	11.2
SBHU - 10M	10	7.9	22	22.0	19	17.2	19.5	48.5	29.4	63.7	37.0	16.2	11.2
SBHU - 12M	12	9.5	24	23.8	22	22.8	22.0	50.8	31.8	71.0	41.9	19.5	12.7
SBHU - 15M	15	11.9	27	27.0	25	24.4	22.0	52.3	32.5	72.5	42.6	22.8	12.7
SBHU - 16M	16	12.7	27	27.0	25	24.4	22.0	52.3	32.5	72.5	42.6	22.8	12.7
SBHU - 18M	18	15.1	30	30.0	30	24.4	22.0	58.7	37.3	78.9	47.4	26.0	16.8
SBHU - 20M	20	15.9	35	35.0	32	26.0	22.0	64.3	42.9	84.5	53.0	29.0	17.0
SBHU - 22M	22	18.3	35	35.0	32	26.0	22.0	64.3	42.9	84.5	53.0	29.0	19.1
SBHU - 25M	25	21.8	41.3	41.3	38	31.3	26.5	71.4	45.2	95.9	57.5	33.7	19.1

h1\* : Metric Tubes Bulkhead Hexagon application only

\* All dimensions in millimeters unless specified as "inch". Dimension are for reference only, subject to change

# SMC

## Male Connector

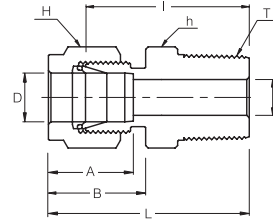

### Connects Fractional Tubes To Female NPT Thread

Part No.	Tube O.D. D (inch)	T (NPT)	d Min	Width Across Flat		A	B	I	L
				h (inch)	H (inch)				
SMC - 1 - 1N	1/16	1/16	1.27	5/16	5/16	8.63	10.92	20.00	23.83
SMC - 1 - 2N	1/16	1/8	1.27	7/16	7/16	8.63	10.92	22.35	26.23
SMC - 2 - 2N	1/8	1/8	2.28	7/16	7/16	12.70	15.24	23.87	30.48
SMC - 2 - 4N	1/8	1/4	2.28	9/16	7/16	12.70	15.24	28.95	35.56
SMC - 2 - 6N	1/8	3/8	2.28	11/16	7/16	12.70	15.24	29.21	35.81
SMC - 2 - 8N	1/8	1/2	2.28	7/8	7/16	12.70	15.24	35.56	42.16
SMC - 3 - 2N	3/16	1/8	3.04	7/16	1/2	13.71	16.00	24.63	31.24
SMC - 3 - 4N	3/16	1/4	3.04	9/16	1/2	13.71	16.00	29.71	36.32
SMC - 4 - 2N	1/4	1/8	4.82	1/2	9/16	15.24	17.78	25.40	32.76
SMC - 4 - 4N	1/4	1/4	4.82	9/16	9/16	15.24	17.78	30.48	37.84
SMC - 4 - 6N	1/4	3/8	4.82	11/16	9/16	15.24	17.78	30.98	38.35
SMC - 4 - 8N	1/4	1/2	4.82	7/8	9/16	15.24	17.78	37.33	44.70
SMC - 4 - 12N	1/4	3/4	4.82	1-1/16	9/16	15.24	17.78	38.86	46.22
SMC - 5 - 2N	5/16	1/8	4.82	9/16	5/8	16.25	18.54	26.67	34.03
SMC - 5 - 4N	5/16	1/4	6.35	9/16	5/8	16.25	18.54	31.24	38.60
SMC - 5 - 6N	5/16	3/8	6.35	11/16	5/8	16.25	18.54	31.75	39.11
SMC - 6 - 2N	3/8	1/8	4.82	5/8	11/16	16.76	19.30	27.94	35.30
SMC - 6 - 4N	3/8	1/4	7.11	5/8	11/16	16.76	19.30	32.51	39.87
SMC - 6 - 6N	3/8	3/8	7.11	11/16	11/16	16.76	19.30	32.51	39.87
SMC - 6 - 8N	3/8	1/2	7.11	7/8	11/16	16.76	19.30	38.86	46.22
SMC - 6 - 12N	3/8	3/4	7.11	1-1/16	11/16	16.76	19.30	40.38	47.75
SMC - 8 - 2N	1/2	1/8	4.82	13/16	7/8	22.86	21.84	28.70	38.86
SMC - 8 - 4N	1/2	1/4	7.11	13/16	7/8	22.86	21.84	33.27	43.43
SMC - 8 - 6N	1/2	3/8	9.65	13/16	7/8	22.86	21.84	33.27	43.43
SMC - 8 - 8N	1/2	1/2	10.41	7/8	7/8	22.86	21.84	38.86	49.02
SMC - 8 - 12N	1/2	3/4	10.41	1-1/16	7/8	22.86	21.84	40.38	50.54
SMC - 8 - 16N	1/2	1	10.41	1-3/8	7/8	22.86	21.84	46.99	57.15
SMC - 10 - 6N	5/8	3/8	9.65	15/16	1	24.38	21.84	34.03	44.19
SMC - 10 - 8N	5/8	1/2	11.93	15/16	1	24.38	21.84	38.86	49.02
SMC - 10 - 12N	5/8	3/4	12.70	1-1/16	1	24.38	21.84	40.38	50.54
SMC - 12 - 8N	3/4	1/2	11.93	1-1/16	1-1/8	24.38	21.84	40.38	50.54
SMC - 12 - 12N	3/4	3/4	15.74	1-1/16	1-1/8	24.38	21.84	40.38	50.54
SMC - 12 - 16N	3/4	1	15.74	1-3/8	1-1/8	24.38	21.84	46.99	57.15
SMC - 14 - 12N	7/8	3/4	15.74	1-3/16	1-1/4	25.90	21.84	40.38	50.54
SMC - 14 - 16N	7/8	1	18.28	1-3/8	1-1/4	25.90	21.84	46.99	57.15
SMC - 16 - 8N	1	1/2	11.93	1-3/8	1-1/2	31.24	26.41	45.21	57.40
SMC - 16 - 12N	1	3/4	15.74	1-3/8	1-1/2	31.24	26.41	45.21	57.40
SMC - 16 - 16N	1	1	22.35	1-3/8	1-1/2	31.24	26.41	50.03	62.23
SMC - 20 - 16N	1-1/4	1	22.35	1-3/4	1-7/8	41.15	38.86	55.12	77.22
SMC - 20 - 20N	1-1/4	1-1/4	27.69	1-3/4	1-7/8	41.15	38.86	55.12	77.22
SMC - 24 - 24N	1-1/2	1-1/2	34.04	2-1/8	2-1/4	50.04	45.21	61.72	88.90
SMC - 32 - 32N	2	2	45.97	2-3/4	3	67.56	62.74	76.20	113.54

\* All dimensions in millimeters unless specified as "inch". Dimension are for reference only, subject to change

## SMC Male Connector

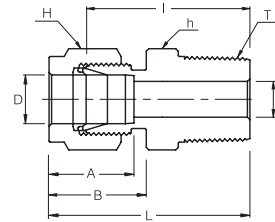

### Connects Fractional Tube To Female ISO Tapered Thread

Part No.	Tube O.D. D (inch)	T R (PT)	d Min	Width Across Flat		A	B	I	L
				h (inch)	H (inch)				
SMC - 2 - 2R	1/8	1/8	2.28	7/16	7/16	12.70	15.24	23.87	30.48
SMC - 2 - 4R	1/8	1/4	2.28	9/16	7/16	12.70	15.24	28.95	35.56
SMC - 4 - 2R	1/4	1/8	4.82	1/2	9/16	15.24	17.78	25.40	32.76
SMC - 4 - 4R	1/4	1/4	4.82	9/16	9/16	15.24	17.78	30.48	37.84
SMC - 4 - 6R	1/4	3/8	4.82	11/16	9/16	15.24	17.78	30.98	38.35
SMC - 4 - 8R	1/4	1/2	4.82	7/8	9/16	15.24	17.78	37.33	44.70
SMC - 5 - 2R	5/16	1/8	4.82	9/16	5/8	16.25	18.54	26.67	34.03
SMC - 5 - 4R	5/16	1/4	6.35	9/16	5/8	16.25	18.54	31.24	38.60
SMC - 6 - 2R	3/8	1/8	4.82	5/8	11/16	16.76	19.30	27.94	35.30
SMC - 6 - 4R	3/8	1/4	7.11	5/8	11/16	16.76	19.30	32.51	39.87
SMC - 6 - 6R	3/8	3/8	7.11	11/16	11/16	16.76	19.30	32.51	39.87
SMC - 6 - 8R	3/8	1/2	7.11	7/8	11/16	16.76	19.30	38.86	46.22
SMC - 8 - 4R	1/2	1/4	7.11	13/16	7/8	22.86	21.84	33.27	43.43
SMC - 8 - 6R	1/2	3/8	9.65	13/16	7/8	22.86	21.84	33.27	43.43
SMC - 8 - 8R	1/2	1/2	10.41	7/8	7/8	22.86	21.84	38.86	49.02
SMC - 8 - 12R	1/2	3/4	10.41	1-1/16	7/8	22.86	21.84	40.38	50.54
SMC - 12 - 12R	3/4	3/4	15.74	1-1/16	1-1/8	24.38	21.84	40.38	50.54
SMC - 16 - 16R	1	1	22.35	1-3/8	1-1/2	31.24	26.41	50.03	62.23

## Bored-through Fittings for Thermocouples

SUPERLOK Bored-through Male Connectors accommodate thermocouples or dip tubes. To order, use TM as a suffix to the desired male connector ordering number.

Note: the root diameter of the pipe thread end of male connectors makes it impractical to bore through all male connectors.

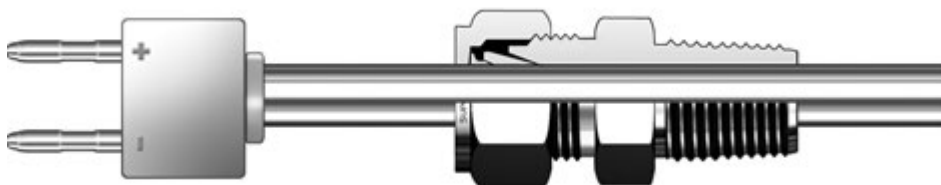

• All dimensions in millimeters unless specified as "inch". Dimension are for reference only, subject to change

# SMC

## Male Connector

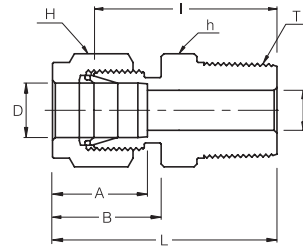

### Connects Metric Tube To Female NPT Thread

Part No.	Tube O.D. D	T (NPT)	d Min	Width Across Flat		A	B	I	L
				h	H				
SMC - 2M - 2N	2	1/8	1.7	12	12	12.9	15.3	23.9	30.5
SMC - 3M - 2N	3	1/8	2.4	12	12	12.9	15.3	23.9	30.5
SMC - 3M - 4N	3	1/4	2.4	14	12	12.9	15.3	29.0	35.6
SMC - 4M - 2N	4	1/8	2.4	12	12	13.7	16.1	24.6	31.2
SMC - 4M - 4N	4	1/4	2.4	14	12	13.7	16.1	29.7	36.3
SMC - 6M - 2N	6	1/8	4.8	14	14	15.3	17.7	25.4	32.8
SMC - 6M - 4N	6	1/4	4.8	14	14	15.3	17.7	30.5	37.9
SMC - 6M - 6N	6	3/8	4.8	18	14	15.3	17.7	31.0	38.4
SMC - 6M - 8N	6	1/2	4.8	22	14	15.3	17.7	37.3	44.7
SMC - 8M - 2N	8	1/8	4.8	15	16	16.2	18.6	26.7	34.2
SMC - 8M - 4N	8	1/4	6.4	15	16	16.2	18.6	31.2	38.7
SMC - 8M - 6N	8	3/8	6.4	18	16	16.2	18.6	31.8	39.3
SMC - 8M - 8N	8	1/2	6.4	22	16	16.2	18.6	38.1	45.6
SMC - 10M - 2N	10	1/8	4.8	18	19	17.2	19.5	28.7	36.3
SMC - 10M - 4N	10	1/4	7.9	18	19	17.2	19.5	33.3	40.9
SMC - 10M - 6N	10	3/8	7.9	18	19	17.2	19.5	33.3	40.9
SMC - 10M - 8N	10	1/2	7.9	22	19	17.2	19.5	38.9	46.5
SMC - 12M - 2N	12	1/8	4.8	22	22	22.8	22.0	28.7	38.8
SMC - 12M - 4N	12	1/4	7.1	22	22	22.8	22.0	33.3	43.4
SMC - 12M - 6N	12	3/8	9.5	22	22	22.8	22.0	33.3	43.4
SMC - 12M - 8N	12	1/2	9.5	22	22	22.8	22.0	38.9	49.0
SMC - 12M - 12N	12	3/4	9.5	27	22	22.8	22.0	40.4	50.5
SMC - 14M - 4N	14	1/4	7.1	24	25	24.4	22.0	34.0	44.1
SMC - 14M - 6N	14	3/8	9.5	24	25	24.4	22.0	34.0	44.1
SMC - 14M - 8N	14	1/2	11.1	24	25	24.4	22.0	38.9	49.0
SMC - 16M - 6N	16	3/8	9.5	24	25	24.4	22.0	34.0	44.1
SMC - 16M - 8N	16	1/2	11.9	24	25	24.4	22.0	38.9	49.0
SMC - 16M - 12N	16	3/4	12.7	27	25	24.4	22.0	40.4	50.5
SMC - 18M - 8N	18	1/2	11.9	27	30	24.4	22.0	40.4	50.5
SMC - 18M - 12N	18	3/4	15.1	27	30	24.4	22.0	40.4	50.5
SMC - 20M - 8N	20	1/2	11.9	30	32	26.0	22.0	42.2	52.3
SMC - 20M - 12N	20	3/4	15.9	30	32	26.0	22.0	42.2	52.3
SMC - 22M - 12N	22	3/4	15.9	30	32	26.0	22.0	42.2	52.3
SMC - 22M - 16N	22	1	18.3	35	32	26.0	22.0	47.0	57.1
SMC - 25M - 12N	25	3/4	15.9	35	38	31.3	26.5	45.2	57.5
SMC - 25M - 16N	25	1	21.8	35	38	31.3	26.5	50.0	62.3
SMC - 28M - 16N	28	1	21.8	41	46	36.6	36.6	51.6	72.4
SMC - 28M - 20N	28	1-1/4	21.8	44.4	46	36.6	36.6	52.3	73.1
SMC - 30M - 20N	30	1-1/4	26.2	46	50	39.6	39.2	55.6	77.2
SMC - 32M - 20N	32	1-1/4	28.6	46	50	42.0	41.6	56.6	79.6
SMC - 38M - 24N	38	1-1/2	33.7	55	60	49.4	47.9	64.0	91.6

\* All dimensions in millimeters unless specified as "inch". Dimension are for reference only, subject to change



# SMC

## Male Connector

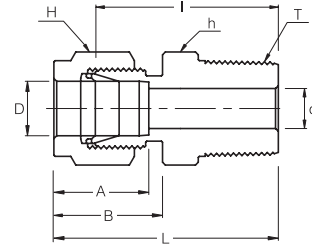

### Connects Metric Tube To Female ISO Tapered Thread

Part No.	Tube O.D. D	T R (PT)	d Min	Width Across Flat		A	B	I	L
				h	H				
SMC - 2M - 2R	2	1/8	1.7	12	12	12.9	15.3	23.9	30.5
SMC - 3M - 2R	3	1/8	2.4	12	12	12.9	15.3	23.9	30.5
SMC - 3M - 4R	3	1/4	2.4	14	12	12.9	15.3	29.0	35.6
SMC - 4M - 2R	4	1/8	2.4	12	12	13.7	16.1	24.6	31.2
SMC - 4M - 4R	4	1/4	2.4	14	12	13.7	16.1	29.7	36.3
SMC - 6M - 2R	6	1/8	4.8	14	14	15.3	17.7	25.4	32.8
SMC - 6M - 4R	6	1/4	4.8	14	14	15.3	17.7	30.5	37.9
SMC - 6M - 6R	6	3/8	4.8	18	14	15.3	17.7	31.0	38.4
SMC - 6M - 8R	6	1/2	4.8	22	14	15.3	17.7	37.3	44.7
SMC - 8M - 2R	8	1/8	4.8	15	16	16.2	18.6	26.7	34.2
SMC - 8M - 4R	8	1/4	6.4	15	16	16.2	18.6	31.2	38.7
SMC - 8M - 6R	8	3/8	6.4	18	16	16.2	18.6	31.8	39.3
SMC - 8M - 8R	8	1/2	6.4	22	16	16.2	18.6	38.1	45.6
SMC - 10M - 2R	10	1/8	4.8	18	19	17.2	19.5	28.7	36.3
SMC - 10M - 4R	10	1/4	7.9	18	19	17.2	19.5	33.3	40.9
SMC - 10M - 6R	10	3/8	7.9	18	19	17.2	19.5	33.3	40.9
SMC - 10M - 8R	10	1/2	7.9	22	19	17.2	19.5	38.9	46.5
SMC - 12M - 4R	12	1/4	7.1	22	22	22.8	22.0	33.3	43.4
SMC - 12M - 6R	12	3/8	9.5	22	22	22.8	22.0	33.3	43.4
SMC - 12M - 8R	12	1/2	9.5	22	22	22.8	22.0	38.9	49.0
SMC - 12M - 12R	12	3/4	9.5	27	22	22.8	22.0	40.4	50.5
SMC - 15M - 8R	15	1/2	11.9	24	25	24.4	22.0	38.9	49.0
SMC - 16M - 4R	16	1/4	7.1	24	25	24.4	22.0	34.0	44.1
SMC - 16M - 6R	16	3/8	9.5	24	25	24.4	22.0	34.0	44.1
SMC - 16M - 8R	16	1/2	11.9	24	25	24.4	22.0	38.9	49.0
SMC - 16M - 12R	16	3/4	12.7	27	25	24.4	22.0	40.4	50.5
SMC - 18M - 8R	18	1/2	11.9	27	30	24.4	22.0	40.4	50.5
SMC - 18M - 12R	18	3/4	15.1	27	30	24.4	22.0	40.4	50.5
SMC - 20M - 8R	20	1/2	11.9	30	32	26.0	22.0	42.2	52.3
SMC - 20M - 12R	20	3/4	15.9	30	32	26.0	22.0	42.2	52.3
SMC - 22M - 12R	22	3/4	15.9	30	32	26.0	22.0	42.2	52.3
SMC - 22M - 16R	22	1	18.3	35	32	26.0	22.0	47.0	57.1
SMC - 25M - 12R	25	3/4	15.9	35	38	31.3	26.5	45.2	57.5
SMC - 25M - 16R	25	1	21.8	35	38	31.3	26.5	50.0	62.3
SMC - 28M - 16R	28	1	21.8	41	46	36.6	36.6	51.6	72.4
SMC - 28M - 20R	28	1-1/4	21.8	44.4	46	36.6	36.6	52.3	73.1
SMC - 30M - 20R	30	1-1/4	26.2	46	50	39.6	39.2	55.6	77.2
SMC - 32M - 20R	32	1-1/4	28.6	46	50	42.0	41.6	56.6	79.6
SMC - 38M - 24R	38	1-1/2	33.7	55	60	49.4	47.9	64.0	91.6

\* All dimensions in millimeters unless specified as "inch". Dimension are for reference only, subject to change

## SMC - GM

Male Connector  
For Metal Gasket Seal

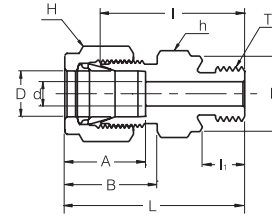

### Connects Metric Tube To Female ISO Parallel Thread

Part No.	Tube O.D. D	T G (PF)	d Min	Width Across Flat		A	B	I	I <sub>1</sub>	L	K
				h	H						
SMC - 3M - 2GM	3	1/8	2.4	14	12	12.9	15.3	23.4	8.0	30.0	14.0
SMC - 3M - 4GM	3	1/4	2.4	19	12	12.9	15.3	28.7	12.0	35.3	18.0
SMC - 4M - 2GM	4	1/8	2.4	14	12	13.7	16.1	24.1	8.0	30.7	14.0
SMC - 6M - 2GM	6	1/8	4.0	14	14	15.3	17.7	24.9	8.0	32.3	14.0
SMC - 6M - 4GM	6	1/4	4.8	19	14	15.3	17.7	30.2	12.0	37.6	18.0
SMC - 6M - 6GM	6	3/8	4.8	22	14	15.3	17.7	31.5	12.0	38.9	22.0
SMC - 6M - 8GM	6	1/2	4.8	27	14	15.3	17.7	37.3	14.0	44.7	26.0
SMC - 8M - 2GM	8	1/8	4.0	15	16	16.2	18.6	25.7	8.0	33.2	14.0
SMC - 8M - 4GM	8	1/4	6.4	19	16	16.2	18.6	31.0	12.0	38.5	18.0
SMC - 8M - 6GM	8	3/8	6.4	22	16	16.2	18.6	32.3	12.0	39.8	22.0
SMC - 8M - 8GM	8	1/2	6.4	27	16	16.2	18.6	38.1	14.0	45.6	26.0
SMC - 10M - 4GM	10	1/4	5.9	19	19	17.2	19.5	31.8	12.0	39.4	18.0
SMC - 10M - 6GM	10	3/8	7.9	22	19	17.2	19.5	33.0	12.0	40.6	22.0
SMC - 10M - 8GM	10	1/2	7.9	27	19	17.2	19.5	38.9	14.0	46.5	26.0
SMC - 12M - 4GM	12	1/4	5.9	22	22	22.8	22.0	32.5	12.0	42.6	18.0
SMC - 12M - 6GM	12	3/8	7.9	22	22	22.8	22.0	33.0	12.0	43.1	22.0
SMC - 12M - 8GM	12	1/2	9.5	27	22	22.8	22.0	38.9	14.0	49.0	26.0
SMC - 12M - 12GM	12	3/4	9.5	35	22	22.8	22.0	42.7	16.0	52.8	32.0
SMC - 15M - 8GM	15	1/2	11.9	27	25	24.4	22.0	38.9	14.0	49.0	26.0
SMC - 16M - 6GM	16	3/8	7.9	24	25	24.4	22.0	33.8	12.0	43.9	22.0
SMC - 16M - 8GM	16	1/2	11.9	27	25	24.4	22.0	38.9	14.0	49.0	26.0
SMC - 18M - 8GM	18	1/2	11.9	27	30	24.4	22.0	38.9	14.0	49.0	26.0
SMC - 18M - 12GM	18	3/4	15.1	35	30	24.4	22.0	42.7	16.0	52.8	32.0
SMC - 20M - 8GM	20	1/2	11.9	30	32	26.0	22.0	40.4	14.0	50.5	26.0
SMC - 20M - 12GM	20	3/4	15.9	35	32	26.0	22.0	42.7	16.0	52.8	32.0
SMC - 22M - 12GM	22	3/4	15.9	35	32	26.0	22.0	42.7	16.0	52.8	32.0
SMC - 22M - 16GM	22	1	18.3	41	32	26.0	22.0	45.2	18.0	55.3	39.0
SMC - 25M - 12GM	25	3/4	15.9	35	38	31.3	26.5	45.2	16.0	57.5	32.0
SMC - 25M - 16GM	25	1	19.8	41	38	31.3	26.5	47.8	18.0	60.1	39.0

\* See page 21 for Explanation of ISO Pipe Thread.

# SGMC

Male Connector  
For Bonded Washer Seal

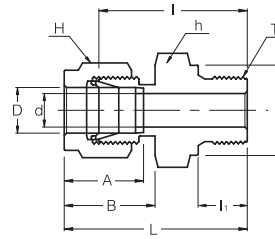

## Connects Metric Tubes To Female ISO Parallel Thread

Part No.	Tube O.D. D	T G (PF)	d Min	Width Across Flat		A	B	I	I <sub>1</sub>	L	K
				h	H						
SGMC - 3M - 2G	3	1/8	2.4	14	12	12.9	15.3	23.4	8.0	30.0	14.0
SGMC - 3M - 4G	3	1/4	2.4	19	12	12.9	15.3	28.7	12.0	35.3	18.0
SGMC - 4M - 2G	4	1/8	2.4	14	12	13.7	16.1	24.1	8.0	30.7	14.0
SGMC - 6M - 2G	6	1/8	4.0	14	14	15.3	17.7	24.9	8.0	32.3	14.0
SGMC - 6M - 4G	6	1/4	4.8	19	14	15.3	17.7	30.2	12.0	37.6	18.0
SGMC - 6M - 6G	6	3/8	4.8	22	14	15.3	17.7	31.5	12.0	38.9	22.0
SGMC - 6M - 8G	6	1/2	4.8	27	14	15.3	17.7	37.3	14.0	44.7	26.0
SGMC - 8M - 2G	8	1/8	4.0	15	16	16.2	18.6	25.7	8.0	33.2	14.0
SGMC - 8M - 4G	8	1/4	6.4	19	16	16.2	18.6	31.0	12.0	38.5	18.0
SGMC - 8M - 6G	8	3/8	6.4	22	16	16.2	18.6	32.3	12.0	39.8	22.0
SGMC - 8M - 8G	8	1/2	6.4	27	16	16.2	18.6	38.1	14.0	45.6	26.0
SGMC - 10M - 4G	10	1/4	5.9	19	19	17.2	19.5	31.8	12.0	39.4	18.0
SGMC - 10M - 6G	10	3/8	7.9	22	19	17.2	19.5	33.0	12.0	40.6	22.0
SGMC - 10M - 8G	10	1/2	7.9	27	19	17.2	19.5	38.9	14.0	46.5	26.0
SGMC - 12M - 4G	12	1/4	5.9	22	22	22.8	22.0	32.5	12.0	42.6	18.0
SGMC - 12M - 6G	12	3/8	7.9	22	22	22.8	22.0	33.0	12.0	43.1	22.0
SGMC - 12M - 8G	12	1/2	9.5	27	22	22.8	22.0	38.9	14.0	49.0	26.0
SGMC - 12M - 12G	12	3/4	9.5	35	22	22.8	22.0	42.7	16.0	52.8	32.0
SGMC - 16M - 6G	16	3/8	7.9	24	25	24.4	22.0	33.8	12.0	43.9	22.0
SGMC - 16M - 8G	16	1/2	11.9	27	25	24.4	22.0	38.9	14.0	49.0	26.0
SGMC - 18M - 8G	18	1/2	11.9	27	30	24.4	22.0	38.9	14.0	49.0	26.0
SGMC - 18M - 12G	18	3/4	15.1	35	30	24.4	22.0	42.7	16.0	52.8	32.0
SGMC - 20M - 8G	20	1/2	11.9	30	32	26.0	22.0	40.4	14.0	50.5	26.0
SGMC - 20M - 12G	20	3/4	15.9	35	32	26.0	22.0	42.7	16.0	52.8	32.0
SGMC - 22M - 12G	22	3/4	15.9	35	32	26.0	22.0	42.7	16.0	52.8	32.0
SGMC - 22M - 16G	22	1	18.3	41	32	26.0	22.0	45.2	18.0	55.3	39.0
SGMC - 25M - 12G	25	3/4	15.9	35	38	31.3	26.5	45.2	16.0	57.5	32.0
SGMC - 25M - 16G	25	1	19.8	41	38	31.3	26.5	47.8	18.0	60.1	39.0

\* See page 21 for Explanation of ISO Pipe Thread.

# SFC

## Female Connector

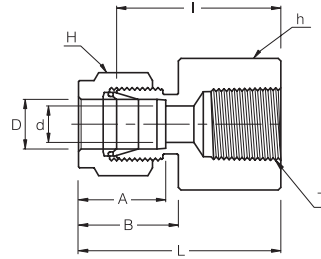

### Connects Fractional Tubes To Male NPT Thread

Part No.	Tube O.D. D (inch)	T* (NPT)	d Min	Width Across Flat		A	B	I	L
				h (inch)	H (inch)				
SFC - 2 - 2N	1/8	1/8	2.28	9/16	7/16	12.70	15.24	22.09	28.70
SFC - 2 - 4N	1/8	1/4	2.28	3/4	7/16	12.70	15.24	26.92	33.52
SFC - 3 - 2N	3/16	1/8	3.04	9/16	1/2	13.71	16.00	23.11	29.71
SFC - 4 - 2N	1/4	1/8	4.82	9/16	9/16	15.24	17.78	23.87	31.24
SFC - 4 - 4N	1/4	1/4	4.82	3/4	9/16	15.24	17.78	28.44	35.81
SFC - 4 - 6N	1/4	3/8	4.82	7/8	9/16	15.24	17.78	30.22	37.59
SFC - 4 - 8N	1/4	1/2	4.82	1-1/16	9/16	15.24	17.78	35.05	42.41
SFC - 5 - 2N	5/16	1/8	6.35	9/16	5/8	16.25	18.54	24.63	32.00
SFC - 5 - 4N	5/16	1/4	6.35	3/4	5/8	16.25	18.54	29.46	36.83
SFC - 6 - 2N	3/8	1/8	7.11	5/8	11/16	16.76	19.30	25.40	32.76
SFC - 6 - 4N	3/8	1/4	7.11	3/4	11/16	16.76	19.30	30.22	37.59
SFC - 6 - 6N	3/8	3/8	7.11	7/8	11/16	16.76	19.30	31.75	39.11
SFC - 6 - 8N	3/8	1/2	7.11	1-1/16	11/16	16.76	19.30	36.57	43.94
SFC - 6 - 12N	3/8	3/4	7.11	1-5/16	11/16	16.76	19.30	40.38	47.75
SFC - 8 - 4N	1/2	1/4	10.41	13/16	7/8	22.86	21.84	30.22	40.38
SFC - 8 - 6N	1/2	3/8	10.41	7/8	7/8	22.86	21.84	31.75	41.91
SFC - 8 - 8N	1/2	1/2	10.41	1-1/16	7/8	22.86	21.84	36.57	46.73
SFC - 8 - 12N	1/2	3/4	10.41	1-5/16	7/8	22.86	21.84	38.10	48.26
SFC -10 - 6N	5/8	3/8	12.70	15/16	1	24.38	21.84	31.75	41.91
SFC -10 - 8N	5/8	1/2	12.70	1-1/16	1	24.38	21.84	36.57	46.73
SFC -12 - 8N	3/4	1/2	15.74	1-1/16	1-1/8	24.38	21.84	36.57	46.73
SFC -12 - 12N	3/4	3/4	15.74	1-5/16	1-1/8	24.38	21.84	38.10	48.26
SFC -14 - 12N	7/8	3/4	18.28	1-5/16	1-1/4	25.90	21.84	39.62	49.78
SFC -16 - 12N	1	3/4	22.35	1-3/8	1-1/2	31.24	26.41	41.14	53.34
SFC -16 - 16N	1	1	22.35	1-5/8	1-1/2	31.24	26.41	50.03	62.23

\* ISO Tapered Threads are available upon request

\* ISO Parallel Threads are available upon request



# SFC

## Female Connector

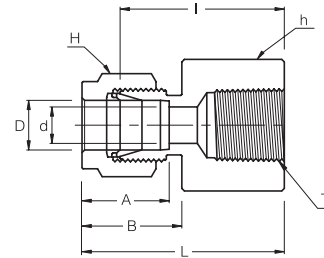

### Connects Metric Tubes To Male ISO Tapered Thread

Part No.	Tube O.D. D	T* R (PT)	d Min	Width Across Flat		A	B	I	L
				h	H				
SFC - 3M - 2R	3	1/8	2.4	14	12	12.9	15.3	22.1	28.7
SFC - 3M - 4R	3	1/4	2.4	19	12	12.9	15.3	26.9	33.5
SFC - 4M - 2R	4	1/8	2.4	14	12	13.7	16.1	23.1	29.7
SFC - 6M - 2R	6	1/8	4.8	14	14	15.3	17.7	23.9	31.3
SFC - 6M - 4R	6	1/4	4.8	19	14	15.3	17.7	28.4	35.8
SFC - 6M - 6R	6	3/8	4.8	22	14	15.3	17.7	30.2	37.6
SFC - 6M - 8R	6	1/2	4.8	27	14	15.3	17.7	35.1	42.5
SFC - 8M - 2R	8	1/8	6.4	15	16	16.2	18.6	24.6	32.1
SFC - 8M - 4R	8	1/4	6.4	19	16	16.2	18.6	29.5	37.0
SFC - 8M - 6R	8	3/8	6.4	22	16	16.2	18.6	31.0	38.5
SFC - 8M - 8R	8	1/2	6.4	27	16	16.2	18.6	35.8	43.3
SFC - 10M - 2R	10	1/8	7.9	18	19	17.2	19.5	25.4	33.0
SFC - 10M - 4R	10	1/4	7.9	19	19	17.2	19.5	30.2	37.8
SFC - 10M - 6R	10	3/8	7.9	22	19	17.2	19.5	31.8	39.4
SFC - 10M - 8R	10	1/2	7.9	27	19	17.2	19.5	36.6	44.2
SFC - 12M - 2R	12	1/8	8.3	22	22	22.8	22.0	25.4	35.5
SFC - 12M - 4R	12	1/4	9.5	22	22	22.8	22.0	30.2	40.3
SFC - 12M - 6R	12	3/8	9.5	22	22	22.8	22.0	31.8	41.9
SFC - 12M - 8R	12	1/2	9.5	27	22	22.8	22.0	36.6	46.7
SFC - 12M - 12R	12	3/4	9.5	35	22	22.8	22.0	38.9	49.0
SFC - 15M - 8R	15	1/2	11.9	27	25	24.4	22.0	36.6	46.7
SFC - 16M - 8R	16	1/2	12.7	27	25	24.4	22.0	36.8	46.9
SFC - 20M - 8R	20	1/2	15.9	30	32	26.0	22.0	37.8	47.9
SFC - 20M - 12R	20	3/4	15.9	35	32	26.0	22.0	39.6	49.7
SFC - 22M - 12R	22	3/4	18.3	35	32	26.0	22.0	39.6	49.7
SFC - 22M - 16R	22	1	18.3	41	32	26.0	22.0	47.8	57.9
SFC - 25M - 12R	25	3/4	21.8	35	38	31.3	26.5	41.1	53.4
SFC - 25M - 16R	25	1	21.8	41	38	31.3	26.5	50.0	62.3

\* NPT Threads are available upon request

\* ISO Parallel Threads are available upon request

# SGC

## Gauge Connector

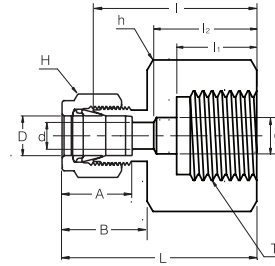

### Connects Fractional Tubes To ISO Parallel Thread

Part No.	Tube O.D. D (inch)	T G (PF)	d Min	d <sub>1</sub>	Width Across Flat		A	B	I	I <sub>1</sub>	I <sub>2</sub>	L
					h (inch)	H (inch)						
SGC - 4 - 4G	1/4	1/4	4.82	5.58	3/4	9/16	15.24	17.78	30.22	13.00	17.00	37.59
SGC - 4 - 6G	1/4	3/8	4.82	6.60	15/16	9/16	15.24	17.78	30.22	14.20	20.30	37.59
SGC - 4 - 8G	1/4	1/2	4.82	6.60	1-1/16	9/16	15.24	17.78	36.07	18.80	24.90	43.43
SGC - 5 - 4G	5/16	1/4	5.58	-	3/4	5/8	16.25	18.54	30.98	13.00	-	38.35
SGC - 5 - 8G	5/16	1/2	7.11	-	1-1/16	5/8	16.25	18.54	33.53	18.80	-	40.89
SGC - 6 - 4G	3/8	1/4	5.58	-	3/4	11/16	16.76	19.30	31.75	13.00	-	39.12
SGC - 6 - 6G	3/8	3/8	6.60	-	15/16	11/16	16.76	19.30	31.24	14.20	-	38.61
SGC - 6 - 8G	3/8	1/2	7.11	-	1-1/16	11/16	16.76	19.30	34.54	18.80	-	41.91
SGC - 8 - 4G	1/2	1/4	5.58	-	7/8	7/8	22.86	21.84	31.80	13.00	-	41.95
SGC - 8 - 6G	1/2	3/8	6.60	-	15/16	7/8	22.86	21.84	34.29	14.20	-	44.45
SGC - 8 - 8G	1/2	1/2	7.11	7.11	1-1/16	7/8	22.86	21.84	38.10	18.80	-	48.26

### Connects Metric Tubes To ISO Parallel Thread

Part No.	Tube O.D. D (inch)	T G (PF)	d Min	d <sub>1</sub>	Width Across Flat		A	B	I	I <sub>1</sub>	I <sub>2</sub>	L
					h	H						
SGC - 3M - 4G	3	1/4	2.4	5.5	19	12	12.9	15.3	28.7	13	17	35.3
SGC - 6M - 4G	6	1/4	4.8	5.5	19	14	15.3	17.7	30.2	13	17	37.6
SGC - 6M - 6G	6	3/8	4.8	6.5	24	14	15.3	17.7	30.2	14	20	37.6
SGC - 6M - 8G	6	1/2	4.8	7.0	27	14	15.3	17.7	36.1	19	25	43.5
SGC - 8M - 4G	8	1/4	5.5	5.5	19	16	16.2	18.6	31.0	13	-	38.5
SGC - 8M - 6G	8	3/8	6.5	6.5	24	16	16.2	18.6	28.7	14	-	36.2
SGC - 8M - 8G	8	1/2	7.0	7.0	27	16	16.2	18.6	33.5	19	-	41.0
SGC - 10M - 4G	10	1/4	5.5	5.5	19	19	17.2	19.5	31.8	13	-	39.4
SGC - 10M - 6G	10	3/8	6.5	6.5	24	19	17.2	19.5	31.2	14	-	38.8
SGC - 10M - 8G	10	1/2	7.0	7.0	27	19	17.2	19.5	34.5	19	-	42.1
SGC - 12M - 4G	12	1/4	5.5	5.5	22	22	22.8	22.0	31.8	13	-	41.9
SGC - 12M - 6G	12	3/8	6.5	6.5	24	22	22.8	22.0	34.3	14	-	44.4
SGC - 12M - 8G	12	1/2	7.0	7.0	27	22	22.8	22.0	38.1	19	-	48.2
SGC - 20M - 8G	20	1/2	7.0	7.0	30	32	26.0	22.0	44.2	19	-	54.3
SGC - 22M - 8G	22	1/2	7.0	7.0	30	32	26.0	22.0	44.2	19	-	54.3

\* See page 21 for Explanation of ISO Pipe Thread.

## SMCB

### Bulkhead Male Connector

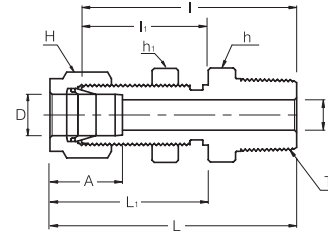

#### Connects Fractional Tubes To Female NPT Thread

Part No.	Tube O.D. D (inch)	T* (NPT)	d Min	Width Across Flat			A	I	I <sub>1</sub>	L	L <sub>1</sub>	Panel Hole Drill Size	Panel Max. Thickness
				h (inch)	h <sub>1</sub> (inch)	H (inch)							
SMCB - 2 - 2N	1/8	1/8	2.28	1/2	1/2	7/16	12.70	39.87	24.63	46.48	31.24	8.33	12.70
SMCB - 4 - 2N	1/4	1/8	4.82	5/8	5/8	9/16	15.24	42.16	26.16	49.53	33.52	11.50	10.16
SMCB - 4 - 4N	1/4	1/4	4.82	5/8	5/8	9/16	15.24	46.73	26.16	54.10	33.52	11.50	10.16
SMCB - 6 - 4N	3/8	1/4	7.11	3/4	3/4	11/16	16.76	50.03	29.46	57.40	36.83	14.68	11.17
SMCB - 6 - 6N	3/8	3/8	7.11	3/4	3/4	11/16	16.76	50.03	29.46	57.40	36.83	14.68	11.17
SMCB - 6 - 8N	3/8	1/2	7.11	7/8	3/4	11/16	16.76	56.38	29.46	63.75	36.83	14.68	11.17
SMCB - 8 - 6N	1/2	3/8	9.65	15/16	15/16	7/8	22.86	53.08	31.75	63.24	41.91	19.44	12.70
SMCB - 8 - 8N	1/2	1/2	10.41	15/16	15/16	7/8	22.86	58.67	31.75	68.83	41.91	19.44	12.70
SMCB - 12 - 12N	3/4	3/4	15.74	1-3/16	1-3/16	1-1/8	24.38	66.04	37.33	76.20	47.49	25.79	16.76
SMCB - 16 - 16N	1	1	22.35	1-5/8	1-5/8	1-1/2	31.24	81.02	45.21	93.21	57.40	33.73	19.05

\* ISO Tapered Threads are available upon request

## SFCB

### Bulkhead Female Connector

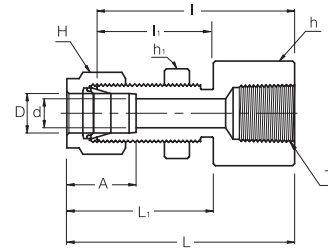

#### Connects Fractional Tubes To Male NPT Thread

Part No.	Tube O.D. D (inch)	T* (NPT)	d Min	Width Across Flat			A	I	I <sub>1</sub>	L	L <sub>1</sub>	Panel Hole Drill Size	Panel Max. Thickness
				h (inch)	h <sub>1</sub> (inch)	H (inch)							
SFCB - 2 - 2N	1/8	1/8	2.28	9/16	1/2	7/16	12.70	38.10	24.63	44.70	31.24	8.33	12.70
SFCB - 4 - 2N	1/4	1/8	4.82	5/8	5/8	9/16	15.24	39.62	26.16	46.99	33.52	11.50	10.16
SFCB - 4 - 4N	1/4	1/4	4.82	3/4	5/8	9/16	15.24	44.45	26.16	51.81	33.52	11.50	10.16
SFCB - 6 - 4N	3/8	1/4	7.11	3/4	3/4	11/16	16.76	47.75	29.46	55.11	36.83	14.68	11.17
SFCB - 8 - 6N	1/2	3/8	10.41	15/16	15/16	7/8	22.86	51.56	31.75	61.72	41.91	19.44	12.70
SFCB - 8 - 8N	1/2	1/2	10.41	1-1/16	15/16	7/8	22.86	56.38	31.75	66.54	41.91	19.44	12.70
SFCB - 12 - 12N	3/4	3/4	15.74	1-1/4	1-3/16	1-1/8	24.38	63.60	37.33	73.51	47.49	25.79	16.76

\* ISO Tapered Threads are available upon request

#### Connects Metric Tubes To Male NPT Thread

Part No.	Tube O.D. D (inch)	T* (NPT)	d Min	Width Across Flat			A	I	I <sub>1</sub>	L	L <sub>1</sub>	Panel Hole Drill Size	Panel Max. Thickness
				h	h <sub>1</sub>	H							
SFCB - 6M - 2N	6	1/8	4.8	15.8	15.8	14	15.3	39.6	27.7	46.90	35.00	11.5	10.2
SFCB - 6M - 4N	6	1/4	4.8	19.0	16.0	14	15.3	44.4	26.2	51.80	33.60	11.5	10.2
SFCB - 8M - 4N	8	1/4	6.3	19.0	17.4	16	16.2	46.7	28.4	53.85	35.55	13.1	11.2
SFCB - 12M - 8N	12	1/2	9.5	27.0	24.0	22	22.8	56.4	31.8	66.50	41.90	19.5	12.7

\* ISO Tapered Threads are available upon request

\* All dimensions in millimeters unless specified as "inch". Dimension are for reference only, subject to change

# SUE

## Union Elbow

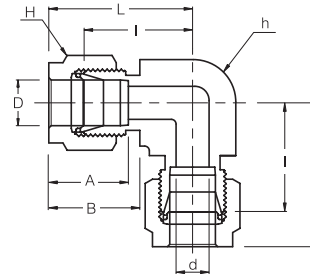

### Connects Fractional Tubes

Part No.	Tube O.D. D (inch)	d Min	Width Across Flat		A	B	I	L
			h (inch)	H (inch)				
SUE - 1	1/16	1.27	3/8	5/16	8.63	10.92	14.00	18.03
SUE - 2	1/8	2.28	3/8	7/16	12.70	15.24	15.74	22.35
SUE - 3	3/16	3.04	1/2	1/2	13.71	16.00	18.54	25.14
SUE - 4	1/4	4.82	1/2	9/16	15.24	17.78	20.10	27.40
SUE - 5	5/16	6.35	5/8	5/8	16.25	18.54	22.35	29.71
SUE - 6	3/8	7.11	5/8	11/16	16.76	19.30	23.11	30.48
SUE - 8	1/2	10.41	13/16	7/8	22.86	21.84	25.90	36.06
SUE - 10	5/8	12.70	15/16	1	24.38	21.84	27.94	38.10
SUE - 12	3/4	15.74	1-1/16	1-1/8	24.38	21.84	29.71	39.87
SUE - 14	7/8	18.28	1-3/8	1-1/4	25.90	21.84	34.54	44.70
SUE - 16	1	22.35	1-3/8	1-1/2	31.24	26.41	36.83	49.02
SUE - 20	1-1/4	27.69	1-11/16	1-7/8	41.15	38.86	44.45	66.55
SUE - 24	1-1/2	34.04	2	2-1/4	50.04	45.21	50.80	77.98
SUE - 32	2	45.97	2-3/4	3	67.56	62.74	69.85	107.19

### Connects Metric Tubes

Part No.	Tube O.D. D	d Min	Width Across Flat		A	B	I	L
			h	H				
SUE 2M	2	1.7	9.5	12	12.9	15.3	15.7	22.3
SUE - 3M	3	2.4	9.5	12	12.9	15.3	15.7	22.3
SUE - 4M	4	2.4	12.7	12	13.7	16.1	18.8	25.4
SUE - 6M	6	4.8	12.7	14	15.3	17.7	19.6	27.0
SUE - 8M	8	6.4	15.9	16	16.2	18.6	22.4	29.9
SUE - 10M	10	7.9	17.5	19	17.2	19.5	23.9	31.5
SUE - 12M	12	9.5	20.6	22	22.8	22.0	25.9	36.0
SUE - 15M	15	11.9	23.8	25	24.4	22.0	27.9	38.8
SUE - 16M	16	12.7	23.8	25	24.4	22.0	27.9	38.0
SUE - 18M	18	15.1	27.0	30	24.4	22.0	29.7	39.8
SUE - 20M	20	15.9	34.9	32	26.0	22.0	34.5	44.6
SUE - 22M	22	18.3	34.9	32	26.0	22.0	34.5	44.6
SUE - 25M	25	21.8	34.9	38	31.3	26.5	36.8	49.1
SUE - 28M	28	21.8	41	46	36.6	36.6	43.2	64.0
SUE - 30M	30	26.2	42.9	50	39.6	39.2	48.3	69.9
SUE - 32M	32	28.6	42.9	50	42.0	41.6	49.3	72.3
SUE - 38M	38	33.7	55	60	49.4	47.9	56.4	84.0

\* All dimensions in millimeters unless specified as "inch". Dimension are for reference only, subject to change

# SME

## Male Elbow

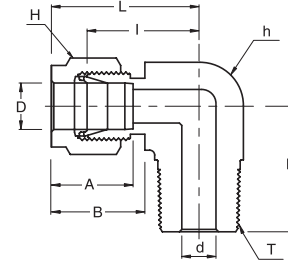

### Connects Metric Tubes To Female NPT Thread

Part No.	Tube O.D. D	T (NPT)	d Min	Width Across Flat		A	B	I	L	L <sub>1</sub>
				h	H					
SME - 3M - 2N	3	1/8	2.4	12.7	12	12.9	15.3	17.0	23.6	17.8
SME - 3M - 4N	3	1/4	2.4	12.7	12	12.9	15.3	18.0	24.6	23.4
SME - 4M - 2N	4	1/8	2.4	12.7	12	13.7	16.1	18.8	25.4	18.8
SME - 4M - 4N	4	1/4	2.4	12.7	12	13.7	16.1	18.8	25.4	23.4
SME - 6M - 2N	6	1/8	4.8	12.7	14	15.3	17.7	19.6	27.0	18.8
SME - 6M - 4N	6	1/4	4.8	12.7	14	15.3	17.7	19.6	27.0	23.4
SME - 6M - 6N	6	3/8	4.8	15.9	14	15.3	17.7	22.4	29.8	26.2
SME - 6M - 8N	6	1/2	4.8	20.6	14	15.3	17.7	24.4	31.8	33.0
SME - 8M - 2N	8	1/8	4.8	14.3	16	16.2	18.6	21.3	28.8	19.8
SME - 8M - 4N	8	1/4	6.4	14.3	16	16.2	18.6	21.3	28.8	24.4
SME - 8M - 6N	8	3/8	6.4	15.9	16	16.2	18.6	23.1	30.6	26.2
SME - 8M - 8N	8	1/2	6.4	20.6	16	16.2	18.6	25.1	32.6	33.0
SME - 10M - 2N	10	1/8	4.8	17.5	19	17.2	19.5	23.9	31.5	21.6
SME - 10M - 4N	10	1/4	7.1	17.5	19	17.2	19.5	23.9	31.5	26.2
SME - 10M - 6N	10	3/8	7.9	17.5	19	17.2	19.5	23.9	31.5	26.2
SME - 10M - 8N	10	1/2	7.9	20.6	19	17.2	19.5	25.9	33.5	33.0
SME - 12M - 4N	12	1/4	7.1	20.6	22	22.8	22.0	25.9	36.0	28.2
SME - 12M - 6N	12	3/8	9.5	20.6	22	22.8	22.0	25.9	36.0	28.2
SME - 12M - 8N	12	1/2	9.5	20.6	22	22.8	22.0	25.9	36.0	33.0
SME - 12M - 12N	12	3/4	9.5	27.0	22	22.8	22.0	29.7	39.8	36.8
SME - 16M - 6N	16	3/8	9.5	23.8	25	24.4	22.0	27.9	38.0	30.2
SME - 16M - 8N	16	1/2	11.9	23.8	25	24.4	22.0	27.9	38.0	35.1
SME - 16M - 12N	16	3/4	12.7	27.0	25	24.4	22.0	29.7	39.8	36.8
SME - 18M - 8N	18	1/2	11.9	27.0	30	24.4	22.0	29.7	39.8	36.8
SME - 18M - 12N	18	3/4	15.1	27.0	30	24.4	22.0	29.7	39.8	36.8
SME - 20M - 8N	20	1/2	11.9	34.9	32	26.0	22.0	34.5	44.6	41.7
SME - 20M - 12N	20	3/4	15.9	34.9	32	26.0	22.0	34.5	44.6	41.7
SME - 22M - 12N	22	3/4	15.9	34.9	32	26.0	22.0	34.5	44.6	41.7
SME - 22M - 16N	22	1	18.3	34.9	32	26.0	22.0	34.5	44.6	46.5
SME - 25M - 12N	25	3/4	15.9	34.9	38	31.3	26.5	36.8	49.1	41.7
SME - 25M - 16N	25	1	21.8	34.9	38	31.3	26.5	36.8	49.1	46.5
SME - 30M - 20N	30	1-1/4	26.2	42.9	50	39.6	39.2	48.3	69.9	53.1
SME - 32M - 20N	32	1-1/4	27.8	42.9	50	42.0	41.6	49.3	72.3	53.1
SME - 38M - 24N	38	1-1/2	33.7	55	60	49.4	47.9	56.4	84.0	60.4

\* All dimensions in millimeters unless specified as "inch". Dimension are for reference only, subject to change

## SME

### Male Elbow

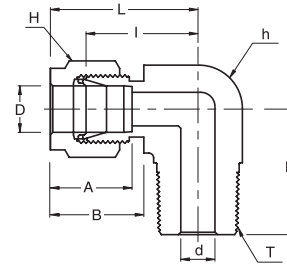

### Connects Metric Tubes To Female ISO Tapered Thread

Part No.	Tube O.D. D	T R (PT)	d Min	Width Across Flat		A	B	I	L	L <sub>1</sub>
				h	H					
SME - 3M - 2R	3	1/8	2.4	12.7	12	12.9	15.3	17.0	23.6	17.8
SME - 3M - 4R	3	1/4	2.4	12.7	12	12.9	15.3	18.0	24.6	23.4
SME - 4M - 2R	4	1/8	2.4	12.7	12	13.7	16.1	18.8	25.4	18.8
SME - 4M - 4R	4	1/4	2.4	12.7	12	13.7	16.1	18.8	25.4	23.4
SME - 6M - 2R	6	1/8	4.8	12.7	14	15.3	17.7	19.6	27.0	18.8
SME - 6M - 4R	6	1/4	4.8	12.7	14	15.3	17.7	19.6	27.0	23.4
SME - 6M - 6R	6	3/8	4.8	15.9	14	15.3	17.7	22.4	29.8	26.2
SME - 6M - 8R	6	1/2	4.8	20.6	14	15.3	17.7	24.4	31.8	33.0
SME - 8M - 2R	8	1/8	4.8	14.3	16	16.2	18.6	21.3	28.8	19.8
SME - 8M - 4R	8	1/4	6.4	14.3	16	16.2	18.6	21.3	28.8	24.4
SME - 8M - 6R	8	3/8	6.4	15.9	16	16.2	18.6	23.1	30.6	26.2
SME - 8M - 8R	8	1/2	6.4	20.6	16	16.2	18.6	25.1	32.6	33.0
SME - 10M - 4R	10	1/4	7.1	17.5	19	17.2	19.5	23.9	31.5	26.2
SME - 10M - 6R	10	3/8	7.9	17.5	19	17.2	19.5	23.9	31.5	26.2
SME - 10M - 8R	10	1/2	7.9	20.6	19	17.2	19.5	25.9	33.5	33.0
SME - 12M - 2R	12	1/8	4.8	20.6	22	22.8	22.0	25.9	36.0	23.6
SME - 12M - 4R	12	1/4	7.1	20.6	22	22.8	22.0	25.9	36.0	28.2
SME - 12M - 6R	12	3/8	9.5	20.6	22	22.8	22.0	25.9	36.0	28.2
SME - 12M - 8R	12	1/2	9.5	20.6	22	22.8	22.0	25.9	36.0	33.0
SME - 12M - 12R	12	3/4	9.5	27.0	22	22.8	22.0	29.7	39.8	36.8
SME - 16M - 6R	16	3/8	9.5	23.8	25	24.4	22.0	27.9	38.0	30.2
SME - 16M - 8R	16	1/2	11.9	23.8	25	24.4	22.0	27.9	38.0	35.1
SME - 18M - 8R	18	1/2	11.9	27.0	30	24.4	22.0	29.7	39.8	36.8
SME - 18M - 12R	18	3/4	15.1	27.0	30	24.4	22.0	29.7	39.8	36.8
SME - 20M - 8R	20	1/2	11.9	34.9	32	26.0	22.0	34.5	44.6	41.7
SME - 20M - 12R	20	3/4	15.9	34.9	32	26.0	22.0	34.5	44.6	41.7
SME - 22M - 12R	22	3/4	15.9	34.9	32	26.0	22.0	34.5	44.6	41.7
SME - 22M - 16R	22	1	18.3	34.9	32	26.0	22.0	34.5	44.6	46.5
SME - 25M - 12R	25	3/4	15.9	34.9	38	31.3	26.5	36.8	49.1	41.7
SME - 25M - 16R	25	1	21.8	34.9	38	31.3	26.5	36.8	49.1	46.5

\* All dimensions in millimeters unless specified as "inch". Dimension are for reference only, subject to change



## SME Male Elbow

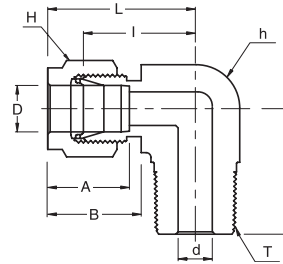

### Connects Fractional Tube To Female NPT Thread

Part No.	Tube O.D. D (inch)	T (NPT)	d Min	Width Across Flat		A	B	I	L	L <sub>1</sub>
				h (inch)	H (inch)					
SME - 2 - 2N	1/8	1/8	2.28	1/2	7/16	12.70	15.24	18.00	24.30	18.80
SME - 2 - 4N	1/8	1/4	2.28	1/2	7/16	12.70	15.24	18.00	24.30	23.36
SME - 3 - 2N	3/16	1/8	3.04	1/2	1/2	13.71	16.00	18.79	25.40	18.79
SME - 3 - 4N	3/16	1/4	3.04	1/2	1/2	13.71	16.00	18.79	25.40	23.36
SME - 4 - 2N	1/4	1/8	4.82	1/2	9/16	15.24	17.78	19.55	26.92	18.79
SME - 4 - 4N	1/4	1/4	4.82	1/2	9/16	15.24	17.78	19.55	26.92	23.36
SME - 4 - 6N	1/4	3/8	4.82	5/8	9/16	15.24	17.78	22.35	29.71	26.16
SME - 4 - 8N	1/4	1/2	4.82	13/16	9/16	15.24	17.78	24.38	31.75	33.02
SME - 5 - 2N	5/16	1/8	4.82	9/16	5/8	16.25	18.54	21.33	28.70	19.81
SME - 5 - 4N	5/16	1/4	6.35	9/16	5/8	16.25	18.54	21.33	28.70	24.38
SME - 5 - 6N	5/16	3/8	6.35	11/16	5/8	16.25	18.54	23.11	30.48	26.16
SME - 6 - 2N	3/8	1/8	4.82	5/8	11/16	16.76	19.30	23.11	30.48	20.82
SME - 6 - 4N	3/8	1/4	7.11	5/8	11/16	16.76	19.30	23.11	30.48	25.40
SME - 6 - 6N	3/8	3/8	7.11	5/8	11/16	16.76	19.30	23.87	31.24	26.16
SME - 6 - 8N	3/8	1/2	7.11	13/16	11/16	16.76	19.30	25.90	33.27	33.02
SME - 6 - 12N	3/8	3/4	7.11	1-1/16	11/16	16.76	19.30	29.71	37.08	36.83
SME - 8 - 4N	1/2	1/4	7.11	13/16	7/8	22.86	21.84	25.90	36.06	28.19
SME - 8 - 6N	1/2	3/8	9.65	13/16	7/8	22.86	21.84	25.90	36.06	28.19
SME - 8 - 8N	1/2	1/2	10.41	13/16	7/8	22.86	21.84	25.90	36.06	33.02
SME - 8 - 12N	1/2	3/4	10.41	1-1/16	7/8	22.86	21.84	29.71	39.87	36.83
SME - 10 - 6N	5/8	3/8	9.65	15/16	1	24.38	21.84	27.94	38.10	30.22
SME - 10 - 8N	5/8	1/2	11.93	15/16	1	24.38	21.84	27.94	38.10	35.10
SME - 10 - 12N	5/8	3/4	12.70	1-1/16	1	24.38	21.84	29.71	39.87	36.83
SME - 12 - 8N	3/4	1/2	11.93	1-1/16	1-1/8	24.38	21.84	29.71	39.87	36.83
SME - 12 - 12N	3/4	3/4	15.74	1-1/16	1-1/8	24.38	21.84	29.71	39.87	36.83
SME - 14 - 12N	7/8	3/4	15.74	1-3/8	1-1/4	25.90	21.84	34.54	44.70	41.65
SME - 16 - 1 2N	1	3/4	15.74	1-3/8	1-1/2	31.24	26.41	36.83	49.02	41.65
SME - 16 - 16N	1	1	22.35	1-3/8	1-1/2	31.24	26.41	36.83	49.02	46.48
SME - 20 - 20N	1-1/4	1-1/4	27.69	1-11/16	1-7/8	41.15	38.86	44.45	66.55	47.75
SME - 24 - 24N	1-1/2	1-1/2	34.04	2	2-1/4	50.04	45.21	50.80	77.98	60.45
SME - 32 - 32N	2	2	45.97	2-3/4	3	67.56	62.74	69.85	107.19	70.61

\* All dimensions in millimeters unless specified as "inch". Dimension are for reference only, subject to change

## SME

### Male Elbow

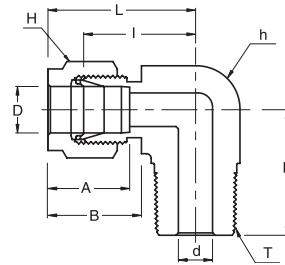

#### Connects Fractional Tubes To Female ISO Tapered Thread

Part No.	Tube O.D. D (inch)	T R (PT)	d Min	Width Across Flat		A	B	I	L	L <sub>1</sub>
				h (inch)	H (inch)					
SME - 4 - 2R	1/4	1/8	4.82	1/2	9/16	15.24	17.78	19.55	26.92	18.79
SME - 4 - 4R	1/4	1/4	4.82	1/2	9/16	15.24	17.78	19.55	26.92	23.36
SME - 4 - 6R	1/4	3/8	4.82	5/8	9/16	15.24	17.78	22.35	29.71	26.16
SME - 4 - 8R	1/4	1/2	4.82	13/16	9/16	15.24	17.78	24.38	31.75	33.02
SME - 5 - 4R	5/16	1/4	6.35	9/16	5/8	16.25	18.54	21.33	28.70	24.38
SME - 6 - 4R	3/8	1/4	7.11	5/8	11/16	16.76	19.30	23.11	30.48	25.40
SME - 6 - 6R	3/8	3/8	7.11	5/8	11/16	16.76	19.30	23.87	31.24	26.16
SME - 8 - 6R	1/2	3/8	9.65	13/16	7/8	22.86	21.84	25.91	36.07	28.20
SME - 8 - 8R	1/2	1/2	10.41	13/16	7/8	22.86	21.84	25.91	36.07	33.02

## SHME

### 45° Male Elbow

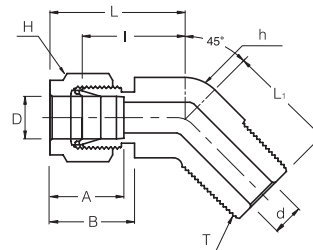

#### Connects Fractional Tubes To Female NPT Thread

Part No.	Tube O.D. D (inch)	T* (NPT)	d Min	Width Across Flat		A	B	I	L	L <sub>1</sub>
				h (inch)	H (inch)					
SHME - 4 - 2N	1/4	1/8	4.82	1/2	9/16	15.24	17.78	17.27	24.63	16.51
SHME - 4 - 4N	1/4	1/4	4.82	1/2	9/16	15.24	17.78	17.27	24.63	21.08
SHME - 6 - 2N	3/8	1/8	4.82	5/8	11/16	16.76	19.30	20.57	27.94	18.28
SHME - 6 - 4N	3/8	1/4	7.11	5/8	11/16	16.76	19.30	20.57	27.94	22.86
SHME - 6 - 6N	3/8	3/8	7.11	13/16	11/16	16.76	19.30	21.84	29.21	24.13
SHME - 8 - 6N	1/2	3/8	9.65	13/16	7/8	22.86	21.84	21.84	32.00	24.13
SHME - 8 - 8N	1/2	1/2	10.41	13/16	7/8	22.86	21.84	21.84	32.00	28.95

\* ISO Tapered Threads are available upon request

\* All dimensions in millimeters unless specified as "inch". Dimension are for reference only, subject to change

## SPHME

### 45° Positionable Male Elbow

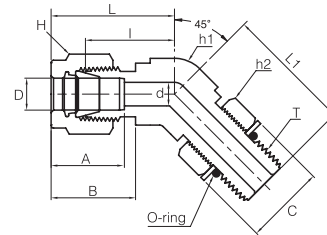

#### Connects Fractional Tubes To SAE/MS Straight Thread

Part No.	Tube O.D. D (inch)	T (U)	d Min	Width Across Flat			A	B	I	L	L1	C
				h1(inch)	h2(inch)	H(inch)						
SPHME - 4 - 4U	1/4	7/16-20	4.83	1/2	9/16	9/16	15.24	17.78	18.29	25.64	25.65	16.51
SPHME - 6 - 6U	3/8	9/16-18	7.11	5/8	11/16	11/16	16.76	19.30	20.57	27.94	28.19	20.07
SPHME - 8 - 8U	1/2	3/4-16	10.41	13/16	7/8	7/8	22.86	21.84	21.84	32.00	32.26	25.65
SPHME - 12 - 12U	3/4	1-1/16-12	15.75	1-1/8	1-1/4	1-1/8	24.38	24.84	29.72	39.88	47.24	36.58
SPHME - 16 - 16U	1	1-5/16-12	22.35	1-3/8	1-1/2	1-1/2	31.24	26.42	35.31	47.50	50.55	43.94

## SPME

### Positionable Male Elbow

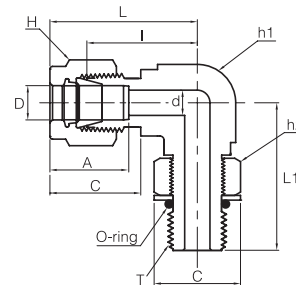

#### Connects Fractional Tubes To SAE/MS Straight Thread

Part No.	Tube O.D. D (inch)	T (U)	d Min	Width Across Flat			A	B	I	L	L1	C
				h1(inch)	h2(inch)	H(inch)						
SPME - 4 - 4U	1/4	7/16-20	4.83	1/2	9/16	9/16	15.24	17.78	21.08	28.45	28.45	16.51
SPME - 4 - 6U	1/4	9/16-18	4.83	5/8	11/16	9/16	15.24	17.78	23.11	30.48	32.26	20.07
SPME - 5 - 5U	5/16	1/2-20	5.84	9/16	5/8	5/8	16.26	18.54	23.60	30.23	29.46	18.29
SPME - 6 - 6U	3/8	9/16-18	7.11	5/8	11/16	11/16	16.76	19.30	24.64	32.00	32.26	20.07
SPME - 6 - 8U	3/8	3/4-16	7.11	13/16	7/8	11/16	16.76	19.30	27.43	34.80	37.85	25.65
SPME - 8 - 8U	1/2	3/4-16	10.41	13/16	7/8	7/8	22.86	21.84	27.43	37.59	37.85	25.65
SPME - 10 - 10U	5/8	7/8-14	12.70	15/16	1	1	24.38	21.84	27.90	39.62	43.43	29.46
SPME - 12 - 12U	3/4	1-1/16-12	15.75	1-1/16	1-1/4	1-1/8	24.38	21.84	29.70	41.40	48.77	36.58
SPME - 14 - 14U	7/8	3/16-12	18.29	1-3/16	1-3/8	1-1/4	25.91	21.84	33.02	43.18	50.55	40.39
SPME - 16 - 16U	1	1-5/16-12	22.35	1-3/8	1-1/2	1-1/2	31.24	26.42	36.80	50.55	53.59	43.94
SPME - 20 - 20U	1-1/4	1-5/8-12	27.69	1-11/16	1-7/8	1-7/8	41.15	38.86	45.72	67.82	58.17	54.86
SPME - 24 - 24U	1-1/2	1-7/8-12	34.04	2	2-1/8	2-1/4	50.04	45.21	50.80	77.98	60.45	62.23
SPME - 32 - 32U	2	2-1/2-12	45.97	2-3/4	2-3/4	3	67.56	62.74	69.85	107.19	71.63	80.26

\* All dimensions in millimeters unless specified as "inch". Dimension are for reference only, subject to change

# SPME

## Positionable Male Elbow

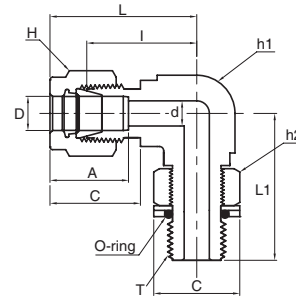

### Connects Fractional Tubes To Female ISO Parallel Thread

Part No.	Tube O.D. D (inch)	T (PF)	d Min	Width Across Flat			A	B	I	L	L1	C
				h1(inch)	h2(inch)	H(inch)						
SPME - 4 - 2G	1/4	1/8	4.06	1/2	9/16	9/16	15.24	17.78	19.56	26.92	26.42	17.27
SPME - 4 - 4G	1/4	1/4	4.83	5/8	3/4	9/16	15.24	17.78	21.59	28.96	32.26	22.86
SPME - 6 - 4G	3/8	1/4	5.84	5/8	3/4	11/16	16.76	19.30	23.60	30.48	32.26	22.86
SPME - 6 - 6G	3/8	3/8	7.11	13/16	7/8	11/16	16.76	19.30	25.91	33.27	37.08	26.42
SPME - 8 - 4G	1/2	1/4	5.84	13/16	3/4	7/8	22.86	21.84	25.91	36.07	35.05	26.42
SPME - 8 - 6G	1/2	3/8	7.87	13/16	7/8	7/8	22.86	21.84	25.91	36.07	37.08	22.86
SPME - 8 - 8G	1/2	1/2	10.41	15/16	1-1/16	7/8	22.86	21.84	27.94	38.10	43.43	26.42
SPME - 10 - 8G	5/8	1/2	11.94	15/16	1-1/16	1	24.38	21.84	27.94	38.10	43.43	32.00
SPME - 12 - 8G	3/4	1/2	11.94	1-1/16	1-1/16	1-1/8	24.38	21.84	29.72	39.88	45.21	32.00
SPME - 12 - 12G	3/4	3/4	15.75	1-1/16	1-3/8	1-1/8	24.38	21.84	29.72	39.88	48.77	41.15
SPME - 16 - 12G	1	3/4	15.75	1-3/8	1-3/8	1-1/2	31.24	26.42	36.83	49.02	53.34	41.15
SPME - 16 - 16G	1	1	19.81	1-3/8	1-5/8	1-1/2	31.24	26.42	36.83	49.02	53.59	48.51

### Connects Metric Tubes To Female ISO Parallel Thread

Part No.	Tube O.D. D	T (PF)	d Min	Width Across Flat			A	B	I	L	L1	C
				h1(inch)	h2(inch)	H						
SPME - 6M - 2G	6	1/8	4.0	1/2	9/16	14	15.3	17.7	19.6	27.0	26.4	17.3
SPME - 6M - 4G	6	1/4	4.8	5/8	3/4	14	15.3	17.7	21.6	29.0	32.3	22.9
SPME - 8M - 2G	8	1/8	4.0	9/16	9/16	16	16.2	18.6	21.3	28.8	27.4	17.3
SPME - 8M - 4G	8	1/4	5.9	5/8	3/4	16	16.2	18.6	22.4	29.9	32.2	22.9
SPME - 10M - 4G	10	1/4	5.9	13/16	3/4	19	17.2	19.5	25.9	33.5	35.0	22.9
SPME - 10M - 6G	10	3/8	7.9	13/16	7/8	19	17.2	19.5	25.9	33.5	37.1	26.4
SPME - 12M - 4G	12	1/4	5.9	13/16	3/4	22	22.8	22.0	25.9	36.0	35.0	22.9
SPME - 12M - 6G	12	3/8	7.9	13/16	7/8	22	22.8	22.0	25.9	36.0	37.1	26.4
SPME - 12M - 8G	12	1/2	9.5	15/16	1-1/16	22	22.8	22.0	27.9	38.0	43.4	32.0
SPME - 12M - 12G	12	3/4	9.5	1-1/16	1-3/8	22	22.8	22.0	29.7	39.8	48.8	41.1

\* All dimensions in millimeters unless specified as "inch". Dimension are for reference only, subject to change

# SFE

## Female Elbow

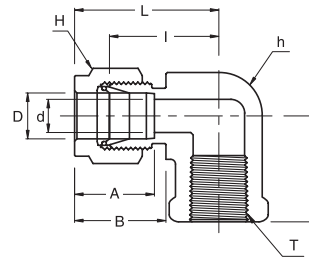

### Connects Fractional Tubes To Male NPT Thread

Part No.	Tube O.D. D (inch)	T* (NPT)	d Min	Width Across Flat		A	B	I	L	L <sub>1</sub>
				h (inch)	H (inch)					
SFE - 2 - 2N	1/8	1/8	2.28	1/2	7/16	12.70	15.24	18.03	24.63	23.40
SFE - 2 - 4N	1/8	1/4	2.28	11/16	7/16	12.70	15.24	20.82	27.43	29.00
SFE - 3 - 2N	3/16	1/8	3.04	1/2	1/2	13.71	16.00	18.79	25.40	23.40
SFE - 4 - 2N	1/4	1/8	4.82	1/2	9/16	15.24	17.78	19.55	26.92	23.40
SFE - 4 - 4N	1/4	1/4	4.82	11/16	9/16	15.24	17.78	22.35	29.71	29.00
SFE - 4 - 6N	1/4	3/8	4.82	13/16	9/16	15.24	17.78	24.38	31.75	22.35
SFE - 4 - 8N	1/4	1/2	4.82	1	9/16	15.24	17.78	27.17	34.54	37.00
SFE - 5 - 2N	5/16	1/8	6.35	9/16	5/8	16.25	18.54	21.33	28.70	19.05
SFE - 5 - 4N	5/16	1/4	6.35	11/16	5/8	16.25	18.54	23.11	30.48	29.00
SFE - 6 - 2N	3/8	1/8	7.11	5/8	11/16	16.76	19.30	23.11	30.48	19.05
SFE - 6 - 4N	3/8	1/4	7.11	11/16	11/16	16.76	19.30	23.87	31.24	29.00
SFE - 6 - 6N	3/8	3/8	7.11	13/16	11/16	16.76	19.30	25.90	33.27	22.35
SFE - 6 - 8N	3/8	1/2	7.11	1	11/16	16.76	19.30	28.70	36.06	37.00
SFE - 8 - 4N	1/2	1/4	10.41	13/16	7/8	22.86	21.84	25.90	36.06	22.35
SFE - 8 - 6N	1/2	3/8	10.41	13/16	7/8	22.86	21.84	25.90	36.06	22.35
SFE - 8 - 8N	1/2	1/2	10.41	1	7/8	22.86	21.84	28.70	38.86	37.00
SFE - 10 - 6N	5/8	3/8	12.70	15/16	1	24.38	21.84	27.94	38.10	22.35
SFE - 10 - 8N	5/8	1/2	12.70	1-1/16	1	24.38	21.84	29.71	39.87	28.44
SFE - 12 - 8N	3/4	1/2	15.74	1-1/16	1-1/8	24.38	21.84	29.71	39.87	28.44
SFE - 12 - 12N	3/4	3/4	15.74	1-3/8	1-1/8	24.38	21.84	34.54	44.70	31.75
SFE - 14 - 12N	7/8	3/4	18.28	1-3/8	1-1/4	25.90	21.84	34.54	44.70	31.75
SFE - 16 - 12N	1	3/4	22.35	1-3/8	1-1/2	31.24	26.41	36.83	49.02	31.75
SFE - 16 - 16N	1	1	22.35	1-11/16	1-1/2	31.24	26.41	41.40	53.59	38.10

\* ISO Tapered Threads are available upon request

### Connects Metric Tubes To Male NPT Thread

Part No.	Tube O.D. D	T* (NPT)	d Min	Width Across Flat		A	B	I	L	L <sub>1</sub>
				h	H					
SFE - 6M - 4N	6	1/4	4.8	17.46	14	15.3	17.7	22.4	29.8	22.40
SFE - 6M - 6N	6	3/8	4.8	20.63	14	15.3	17.7	24.4	31.7	22.40
SFE - 6M - 8N	6	1/2	4.8	25.40	14	15.3	17.7	27.2	34.6	37.00
SFE - 8M - 4N	8	1/4	6.4	17.46	16	16.2	18.6	23.1	30.6	29.00
SFE - 8M - 8N	8	1/2	6.4	25.40	16	16.2	18.6	28.0	35.2	37.00
SFE - 10M - 4N	10	1/4	7.9	17.46	19	17.2	19.5	25.9	33.5	29.00
SFE - 10M - 6N	10	3/8	7.9	20.63	19	17.2	19.5	25.9	33.5	22.40
SFE - 10M - 8N	10	1/2	7.9	25.40	19	17.2	19.5	28.7	36.1	37.00
SFE - 12M - 6N	12	3/8	9.5	20.63	22	22.8	22.0	25.9	36.2	22.35
SFE - 12M - 8N	12	1/2	9.5	25.40	22	22.8	22.0	28.7	38.8	37.00

\* ISO Tapered Threads are available upon request

\* All dimensions in millimeters unless specified as "inch". Dimension are for reference only, subject to change

# SUT

## Union Tee

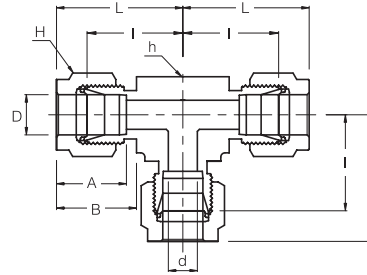

### Connects Fractional Tubes

Part No.	Tube O.D. D (inch)	d Min	Width Across Flat		A	B	I	L
			h (inch)	H (inch)				
SUT - 1	1/16	1.27	3/8	5/16	8.63	10.92	14.00	18.03
SUT - 2	1/8	2.28	3/8	7/16	12.70	15.24	15.80	22.35
SUT - 3	3/16	3.04	1/2	1/2	13.71	16.00	18.54	25.14
SUT - 4	1/4	4.82	1/2	9/16	15.24	17.78	20.10	27.40
SUT - 5	5/16	6.35	5/8	5/8	16.25	18.54	22.35	29.71
SUT - 6	3/8	7.11	5/8	11/16	16.76	19.30	23.11	30.48
SUT - 8	1/2	10.41	13/16	7/8	22.86	21.84	25.90	36.06
SUT - 10	5/8	12.70	1	1	24.38	21.84	28.70	38.86
SUT - 12	3/4	15.74	1-1/16	1-1/8	24.38	21.84	29.71	39.87
SUT - 14	7/8	18.28	1-3/8	1-1/4	25.90	21.84	34.54	44.70
SUT - 16	1	22.35	1-3/8	1-1/2	31.24	26.41	36.83	49.02
SUT - 20	1-1/4	27.69	1-11/16	1-7/8	41.15	38.86	44.45	66.55
SUT - 24	1-1/2	34.04	2	2-1/4	50.04	45.21	50.80	77.98
SUT - 32	2	45.97	2-3/4	3	67.56	62.74	69.85	107.19

### Connects Metric Tubes

Part No.	Tube O.D. D	d Min	Width Across Flat		A	B	I	L
			h	H				
SUT - 2M	2	1.7	9.5	12	12.9	15.3	15.7	22.3
SUT - 3M	3	2.4	9.5	12	12.9	15.3	15.7	22.3
SUT - 4M	4	2.4	12.7	12	13.7	16.1	18.8	25.4
SUT - 6M	6	4.8	12.7	14	15.3	17.7	19.6	27.0
SUT - 8M	8	6.4	15.9	16	16.2	18.6	22.4	29.9
SUT - 10M	10	7.9	17.5	19	17.2	19.5	23.9	31.5
SUT - 12M	12	9.5	20.6	22	22.8	22.0	25.9	36.0
SUT - 15M	15	11.9	25.4	25	24.4	22.0	28.7	38.8
SUT - 16M	16	12.7	25.4	25	24.4	22.0	28.7	38.8
SUT - 18M	18	15.1	27.0	30	24.4	22.0	29.7	38.8
SUT - 20M	20	15.9	34.9	32	26.0	22.0	34.5	44.6
SUT - 22M	22	18.3	34.9	32	26.0	22.0	34.5	44.6
SUT - 25M	25	21.8	34.9	38	31.3	26.5	36.8	49.1
SUT - 28M	28	21.8	41	46	36.6	36.6	43.2	64.0
SUT - 30M	30	26.2	42.9	50	39.6	39.2	48.3	69.9
SUT - 32M	32	28.6	42.9	50	42.0	41.6	49.3	72.3
SUT - 38M	38	33.7	55	60	49.4	47.9	56.4	84.0

\* All dimensions in millimeters unless specified as "inch". Dimension are for reference only, subject to change



# SRUT

## Reducing Union Tee

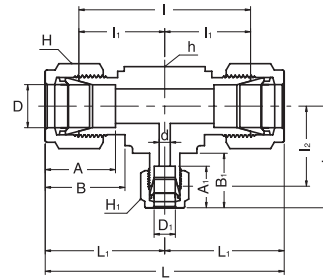

### Connects Fractional Tubes

Part No.	Tube O.D.		d Min	Width Across Flat			A	A <sub>1</sub>	B	B <sub>1</sub>	I	I <sub>1</sub>	I <sub>2</sub>	L	L <sub>1</sub>	L <sub>2</sub>
	D (inch)	D <sub>1</sub> (inch)		h (inch)	H (inch)	H <sub>1</sub> (inch)										
SRUT - 6 - 4	3/8	1/4	4.82	5/8	11/16	9/16	16.76	15.24	19.30	17.78	46.22	23.11	21.59	60.96	30.48	28.95
SRUT - 8 - 4	1/2	1/4	4.82	13/16	7/8	9/16	22.86	15.24	21.84	17.78	51.81	25.90	24.38	72.13	36.06	31.75
SRUT - 8 - 6	1/2	3/8	7.11	13/16	7/8	11/16	22.86	16.76	21.84	19.30	51.81	25.90	25.90	72.13	36.06	33.27
SRUT - 10 - 6	5/8	3/8	7.11	1	1	11/16	24.38	16.76	21.84	19.30	57.40	28.70	28.70	77.72	38.86	36.06
SRUT - 12 - 6	3/4	3/8	7.11	1 1/16	1 1/8	11/16	24.38	16.76	21.84	19.30	59.43	29.71	29.71	79.75	39.87	37.08
SRUT - 12 - 8	3/4	1/2	10.41	1 1/16	1 1/8	7/8	24.38	22.86	21.84	21.84	59.43	29.71	29.71	79.75	39.87	39.87
SRUT - 16 - 6	1	3/8	7.11	1 3/8	1 1/2	1 1/16	31.24	16.76	26.41	19.30	73.66	36.83	34.54	98.04	49.02	41.91
SRUT - 16 - 8	1	1/2	10.41	1 3/8	1 1/2	7/8	31.24	21.84	26.41	22.86	73.66	36.83	34.54	98.04	49.02	44.70
SRUT - 16 - 12	1	3/4	15.74	1 3/8	1 1/2	1 1/8	31.24	24.38	26.41	21.84	73.66	36.83	34.54	98.04	49.02	44.70

\* All dimensions in millimeters unless specified as "inch". Dimension are for reference only, subject to change

# SMBT

## Male Branch Tee

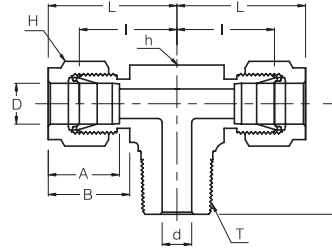

### Connects Fractional Tubes To Female NPT Thread

Part No.	Tube O.D. D (inch)	T * (NPT)	d Min	Width Across Flat		A	B	I	L	L <sub>1</sub>
				h (inch)	H (inch)					
SMBT - 2 - 2N	1/8	1/8	2.28	1/2	7/16	12.70	15.24	18.30	24.91	18.90
SMBT - 2 - 4N	1/8	1/4	2.28	1/2	7/16	12.70	15.24	18.03	24.63	23.36
SMBT - 3 - 2N	3/16	1/8	3.04	1/2	1/2	13.71	16.00	17.78	25.40	18.79
SMBT - 4 - 2N	1/4	1/8	4.82	1/2	9/16	15.24	17.78	19.55	26.92	18.79
SMBT - 4 - 4N	1/4	1/4	4.82	1/2	9/16	15.24	17.78	19.55	26.92	23.36
SMBT - 5 - 2N	5/16	1/8	4.82	5/8	5/8	16.25	18.54	22.35	29.71	20.82
SMBT - 6 - 4N	3/8	1/4	7.11	5/8	11/16	16.76	19.30	23.11	30.48	25.40
SMBT - 6 - 6N	3/8	3/8	7.11	5/8	11/16	16.76	19.30	23.10	30.48	28.19
SMBT - 8 - 6N	1/2	3/8	9.65	13/16	7/8	22.86	21.84	25.90	36.06	28.19
SMBT - 8 - 8N	1/2	1/2	10.41	13/16	7/8	22.86	21.84	25.90	36.06	33.02
SMBT - 10 - 8N	5/8	1/2	11.93	1	1	24.38	21.84	28.70	38.86	35.81
SMBT - 12 - 12N	3/4	3/4	15.74	1-1/16	1-1/8	24.38	21.84	29.71	39.87	36.83

\* ISO Tapered Threads are available upon request

### Connects Metric Tubes To Female ISO Tapered Thread

Part No.	Tube O.D. D	T * R (PT)	d Min	Width Across Flat		A	B	I	L	L <sub>1</sub>
				h	H					
SMBT - 3M - 2R	3	1/8	2.4	12.7	12	12.9	15.3	17.0	23.6	17.8
SMBT - 3M - 4R	3	1/4	2.4	12.7	12	12.9	15.3	18.0	24.6	23.4
SMBT - 4M - 2R	4	1/8	2.4	12.7	12	13.7	16.1	18.8	25.4	18.8
SMBT - 6M - 2R	6	1/8	4.8	12.7	14	15.3	17.7	19.6	27.0	18.8
SMBT - 6M - 4R	6	1/4	4.8	12.7	14	15.3	17.7	19.6	27.0	23.4
SMBT - 8M - 2R	8	1/8	4.8	15.9	16	16.2	18.6	22.4	29.9	20.8
SMBT - 8M - 4R	8	1/4	6.4	15.9	16	16.2	18.6	22.4	29.9	25.4
SMBT - 10M - 4R	10	1/4	7.1	17.5	19	17.2	19.5	23.9	31.5	28.2
SMBT - 10M - 6R	10	3/8	7.9	17.5	19	17.2	19.5	23.9	31.5	28.2
SMBT - 12M - 4R	12	1/4	7.1	20.6	22	22.8	22.0	25.9	36.0	28.2
SMBT - 12M - 6R	12	3/8	9.5	20.6	22	22.8	22.0	25.9	36.0	28.2
SMBT - 12M - 8R	12	1/2	9.5	20.6	22	22.8	22.0	25.9	36.0	33.0
SMBT - 16M - 6R	16	3/8	9.5	25.4	25	24.4	22.0	27.9	38.0	30.2
SMBT - 16M - 8R	16	1/2	11.9	25.4	25	24.4	22.0	27.9	38.0	35.1
SMBT - 20M - 12R	20	3/4	15.9	31.8	32	26.0	22.0	34.5	44.6	41.7

\* NPT Threads are available upon request

\* All dimensions in millimeters unless specified as "inch". Dimension are for reference only, subject to change

# SPMBT

## Positionable Male Branch Tee

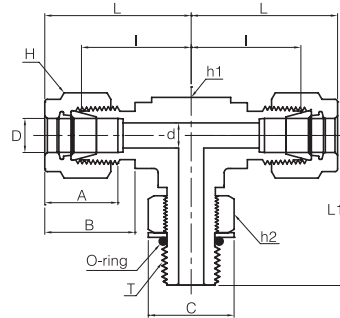

### Connects Fractional Tubes To Female ISO Parallel Thread

Part No.	Tube O.D. D (inch)	T (PF)	d Min	Width Across Flat			A	B	I	L	L1	C
				h1(inch)	h2(inch)	H(inch)						
SPMBT - 4 - 2G	1/4	1/8	4.06	1/2	9/16	9/16	15.24	17.78	19.56	26.92	26.42	17.27
SPMBT - 4 - 4G	1/4	1/4	4.83	5/8	3/4	9/16	15.24	17.78	21.59	28.96	32.26	22.86
SPMBT - 6 - 4G	3/8	1/4	5.08	5/8	3/4	11/16	15.24	19.30	23.11	30.48	32.26	22.86
SPMBT - 8 - 6G	3/8	3/8	7.87	13/16	7/8	7/8	22.86	21.84	25.91	36.07	37.08	26.42
SPMBT - 8 - 8G	1/2	1/2	10.41	15/16	1-1/16	7/8	22.86	21.84	27.94	38.10	43.43	32.00
SPMBT - 10 - 8G	5/8	1/2	11.94	15/16	1-1/16	1	24.38	21.84	27.94	38.10	43.43	32.00
SPMBT - 12 - 8G	3/4	1/2	11.94	1-1/16	1-1/16	1-1/8	24.38	21.84	29.72	39.88	45.21	32.00
SPMBT - 12 - 12G	3/4	3/4	15.75	1-1/16	1-3/8	1-1/8	24.38	21.84	29.72	39.88	48.77	41.15
SPMBT - 16 - 16G	1	1	19.81	1-3/8	1-5/8	1-1/2	31.24	26.42	36.83	49.02	53.59	48.51

### Connects Metric Tubes To Female ISO Parallel Thread

Part No.	Tube O.D. D	T (PF)	d Min	Width Across Flat			A	B	I	L	L1	C
				h1(inch)	h2(inch)	H						
SPMBT - 6M - 2G	6	1/8	4.0	1/2	9/16	14	15.3	17.7	19.6	27.0	26.4	17.3
SPMBT - 6M - 4G	6	1/4	4.8	5/8	3/4	14	15.3	17.7	21.6	29.0	32.3	22.9
SPMBT - 8M - 2G	8	1/8	4.0	9/16	9/16	16	16.2	18.6	21.3	28.8	27.4	17.3
SPMBT - 8M - 4G	8	1/4	5.9	5/8	3/4	16	16.2	18.6	22.4	29.9	32.2	22.9
SPMBT - 10M - 4G	10	1/4	5.9	13/16	3/4	19	17.2	19.5	25.9	33.5	35.0	22.9
SPMBT - 12M - 6G	10	3/8	7.9	13/16	7/8	22	22.8	22.0	25.9	36.0	37.1	26.4
SPMBT - 12M - 8G	12	1/4	9.5	15/16	1-1/16	22	22.8	22.0	27.9	38.0	35.0	32.0

### Connects Fractional Tubes To SAE/MS Straight Thread Boss

Part No.	Tube O.D. D (inch)	T (U)	d Min	Width Across Flat			A	B	I	L	L1	C
				h1(inch)	h2(inch)	H(inch)						
SPMBT - 4 - 4U	1/4	7/16-20	4.83	1/2	9/16	9/16	15.24	17.78	21.08	28.45	28.45	16.51
SPMBT - 6 - 6U	3/8	9/16-18	7.11	5/8	11/16	11/16	16.76	19.30	24.64	32.00	32.26	20.07
SPMBT - 8 - 8U	1/2	3/4-16	10.41	13/16	7/8	7/8	22.86	21.84	27.43	37.59	37.85	25.65
SPMBT - 12 - 12U	3/4	1-1/16-12	15.75	1-1/16	1-1/4	1-1/8	24.38	21.84	31.24	41.40	48.77	36.58
SPMBT - 16 - 16U	1	1-5/16-12	22.35	1-3/8	1-1/2	1-1/2	31.24	26.42	38.35	50.55	53.59	43.94
SPMBT - 20 - 20U	1-1/4	1-5/8-12	27.69	1-11/16	1-7/8	1-7/8	41.15	38.86	45.72	67.82	58.17	54.86
SPMBT - 24 - 24U	1-1/2	1-7/8-12	34.04	2	2-1/8	2-1/4	50.04	45.21	50.80	77.98	60.45	62.23
SPMBT - 32 - 32U	2	2-1/2-12	45.97	2-3/4	2-3/4	3	67.56	62.74	69.85	107.19	71.63	80.26

\* All dimensions in millimeters unless specified as "inch". Dimension are for reference only, subject to change

# SMRT

## Male Run Tee

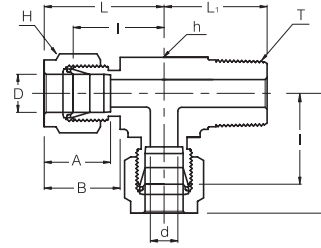

### Connects Fractional Tubes To Female NPT Thread

Part No.	Tube O.D. D (inch)	T * (NPT)	d Min	Width Across Flat		A	B	I	L	L <sub>1</sub>
				h (inch)	H (inch)					
SMRT - 2 - 2N	1/8	1/8	2.28	1/2	7/16	12.70	15.24	18.30	24.91	18.90
SMRT - 2 - 4N	1/8	1/4	2.28	1/2	7/16	12.70	15.24	18.03	24.63	23.36
SMRT - 3 - 2N	3/16	1/8	3.04	1/2	1/2	13.71	16.00	17.78	25.40	18.79
SMRT - 4 - 2N	1/4	1/8	4.82	1/2	9/16	15.24	17.78	19.55	26.92	18.79
SMRT - 4 - 4N	1/4	1/4	4.82	1/2	9/16	15.24	17.78	19.55	26.92	23.36
SMRT - 5 - 2N	5/16	1/8	4.82	5/8	5/8	16.25	18.54	22.35	29.71	20.82
SMRT - 6 - 4N	3/8	1/4	7.11	5/8	11/16	16.76	19.30	23.11	30.48	25.40
SMRT - 6 - 6N	3/8	3/8	7.11	5/8	11/16	16.76	19.30	23.10	30.48	28.19
SMRT - 8 - 6N	1/2	3/8	9.65	13/16	7/8	22.86	21.84	25.90	36.06	28.19
SMRT - 8 - 8N	1/2	1/2	10.41	13/16	7/8	22.86	21.84	25.90	36.06	33.02
SMRT - 10 - 8N	5/8	1/2	11.93	1	1	24.38	21.84	28.70	38.86	35.81
SMRT - 12 - 12N	3/4	3/4	15.74	1-1/16	1-1/8	24.38	21.84	29.71	39.87	36.83

\* ISO Tapered Threads are available upon request

### Connects Metric Tubes To Female ISO Tapered Thread

Part No.	Tube O.D. D	T * R (PT)	d Min	Width Across Flat		A	B	I	L	L <sub>1</sub>
				h	H					
SMRT - 3M - 2R	3	1/8	2.4	12.7	12	12.9	15.3	17.0	23.6	17.8
SMRT - 3M - 4R	3	1/4	2.4	12.7	12	12.9	15.3	18.0	24.6	23.4
SMRT - 4M - 2R	4	1/8	2.4	12.7	12	13.7	16.1	18.8	25.4	18.8
SMRT - 6M - 2R	6	1/8	4.8	12.7	14	15.3	17.7	19.6	27.0	18.8
SMRT - 6M - 4R	6	1/4	4.8	12.7	14	15.3	17.7	19.6	27.0	23.4
SMRT - 8M - 2R	8	1/8	4.8	15.9	16	16.2	18.6	22.4	29.9	20.8
SMRT - 8M - 4R	8	1/4	6.4	15.9	16	16.2	18.6	22.4	29.9	25.4
SMRT - 10M - 4R	10	1/4	7.1	17.5	19	17.2	19.5	23.9	31.5	28.2
SMRT - 10M - 6R	10	3/8	7.9	17.5	19	17.2	19.5	23.9	31.5	28.2
SMRT - 12M - 4R	12	1/4	7.1	20.6	22	22.8	22.0	25.9	36.0	28.2
SMRT - 12M - 6R	12	3/8	9.5	20.6	22	22.8	22.0	25.9	36.0	28.2
SMRT - 12M - 8R	12	1/2	9.5	20.6	22	22.8	22.0	25.9	36.0	33.0
SMRT - 16M - 6R	16	3/8	9.5	25.4	25	24.4	22.0	27.9	38.0	30.2
SMRT - 16M - 8R	16	1/2	11.9	25.4	25	24.4	22.0	27.9	38.0	35.1
SMRT - 20M - 12R	20	3/4	15.9	31.8	32	26.0	22.0	34.5	44.6	41.7

\* NPT Threads are available upon request

\* All dimensions in millimeters unless specified as "inch". Dimension are for reference only, subject to change

# SPMRT

## Positionable Male Run Tee

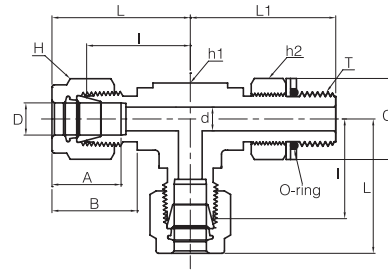

### Connects Fractional Tubes To Female ISO Parallel Thread

Part No.	Tube O.D. D (inch)	T (PF)	d Min	Width Across Flat			A	B	I	L	L1	C
				h1(inch)	h2(inch)	H(inch)						
SPMRT - 4 - 2G	1/4	1/8	4.06	1/2	9/16	9/16	15.24	17.78	19.56	26.92	26.42	17.27
SPMRT - 4 - 4G	1/4	1/4	4.83	5/8	3/4	9/16	15.24	17.78	21.59	28.96	32.26	22.86
SPMRT - 6 - 4G	3/8	1/4	5.84	5/8	3/4	11/16	16.76	19.30	23.11	30.48	32.26	22.86
SPMRT - 8 - 6G	1/4	3/8	7.87	13/16	7/8	7/8	22.86	21.84	25.91	36.07	37.08	26.42
SPMRT - 8 - 8G	3/8	1/2	10.41	15/16	1-1/16	7/8	22.86	21.84	27.94	38.10	43.43	32.00
SPMRT - 10 - 8G	1/2	1/2	11.94	15/16	1-1/16	1	24.38	21.84	27.94	38.10	43.43	32.00
SPMRT - 12 - 8G	3/4	1/2	11.94	1-1/16	1-1/16	1-1/8	24.38	21.84	29.72	39.88	45.21	32.00
SPMRT - 12 - 12G	3/4	3/4	15.75	1-1/16	1-3/8	1-1/8	24.38	21.84	29.72	39.88	48.77	41.15
SPMRT - 16 - 16G	1	1	19.81	1-3/8	1-5/8	1-1/2	31.24	26.42	36.83	49.02	53.59	48.51

### Connects Metric Tubes To Female ISO Parallel Thread

Part No.	Tube O.D. D	T (PF)	d Min	Width Across Flat			A	B	I	L	L1	C
				h1(inch)	h2(inch)	H						
SPMRT - 6M - 2G	6	1/8	4.0	1/2	9/16	14	15.3	17.7	19.6	27.0	26.4	17.3
SPMRT - 6M - 4G	6	1/4	4.8	5/8	3/4	14	15.3	17.7	21.6	29.0	32.2	22.9
SPMRT - 8M - 2G	8	1/8	4.0	9/16	9/16	16	16.2	18.6	21.3	28.8	27.4	17.3
SPMRT - 8M - 4G	8	1/4	6.4	5/8	3/4	16	16.2	18.6	22.4	29.9	32.2	22.9
SPMRT - 10M - 4G	10	1/4	5.9	13/16	3/4	19	17.2	19.5	25.9	33.5	35.0	22.9
SPMRT - 12M - 6G	10	3/8	7.9	13/16	7/8	22	22.8	22.0	25.9	36.0	37.1	26.4
SPMRT - 12M - 8G	12	1/2	9.5	15/16	1-1/16	22	22.8	22.0	27.9	38.0	43.4	22.9

### Connects Fractional Tubes To SAE/MS Straight Thread

Part No.	Tube O.D. D (inch)	T (U)	d Min	Width Across Flat			A	B	I	L	L1	C
				h1(inch)	h2(inch)	H(inch)						
SPMRT - 4 - 4U	1/4	7/16-20	4.83	1/2	9/16	9/16	15.24	17.78	21.08	28.45	28.45	16.51
SPMRT - 6 - 6U	3/8	9/16-18	7.11	5/8	11/16	11/16	16.76	19.30	24.64	32.00	32.26	20.07
SPMRT - 8 - 8U	1/2	3/4-16	10.41	13/16	7/8	7/8	22.86	21.84	27.43	37.59	37.85	25.65
SPMRT - 12 - 12U	3/4	1-1/16-12	15.75	1-1/16	1-1/4	1-1/8	24.38	21.84	31.24	41.40	48.77	36.58
SPMRT - 16 - 16U	1	1-5/16-12	22.35	1-3/8	1-1/2	1-1/2	31.24	26.42	38.35	50.55	53.59	43.94
SPMRT - 20 - 20U	1-1/4	1-5/8-12	27.69	1-11/16	1-7/8	1-7/8	41.15	38.86	45.72	67.82	58.17	54.86
SPMRT - 24 - 24U	1-1/2	1-7/8-12	34.04	2	2-1/8	2-1/4	50.04	45.21	50.80	77.98	60.45	62.23
SPMRT - 32 - 32U	2	2-1/2-12	45.97	2-3/4	2-3/4	3	67.56	62.74	69.85	107.19	71.63	80.26

\* All dimensions in millimeters unless specified as "inch". Dimension are for reference only, subject to change

# SFBT

## Female Branch Tee

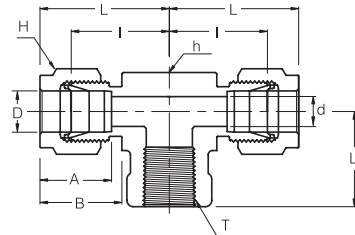

### Connects Fractional Tubes To Male NPT Thread

Part No.	Tube O.D. D (inch)	T * (NPT)	d Min	Width Across Flat		A	B	I	L	L <sub>1</sub>
				h (inch)	H (inch)					
SFBT - 2 - 2N	1/8	1/8	2.28	1/2	7/16	12.70	15.24	18.03	24.63	19.05
SFBT - 4 - 2N	1/4	1/8	4.82	1/2	9/16	15.24	17.78	19.55	26.92	19.05
SFBT - 4 - 4N	1/4	1/4	4.82	11/16	9/16	15.24	17.78	22.35	29.71	22.35
SFBT - 6 - 4N	3/8	1/4	7.11	11/16	11/16	16.76	19.30	23.87	31.24	22.35
SFBT - 6 - 6N	3/8	3/8	7.11	13/16	11/16	16.76	19.30	25.90	33.27	22.35
SFBT - 6 - 8N	3/8	1/2	7.11	1	11/16	16.76	19.30	28.70	36.07	28.45
SFBT - 8 - 4N	1/2	1/4	10.41	13/16	7/8	22.86	21.84	25.90	36.06	22.35
SFBT - 8 - 6N	1/2	3/8	10.41	13/16	7/8	22.86	21.84	25.90	36.06	22.35
SFBT - 8 - 8N	1/2	1/2	10.41	1	7/8	22.86	21.84	28.70	38.86	28.44
SFBT - 10 - 8N	5/8	1/2	12.70	1	1	24.38	21.84	28.70	38.86	28.44
SFBT - 12 - 12N	3/4	3/4	15.74	1-3/8	1-1/8	24.38	21.84	34.54	44.70	31.75
SFBT - 16 - 12N	1	3/4	22.35	1-3/8	1-1/2	31.24	26.41	36.83	49.02	31.75
SFBT - 16 - 16N	1	1	22.35	1-11/16	1-1/2	31.24	26.41	41.40	53.59	38.10

\* ISO Tapered Threads are available upon request

### Connects Metric Tubes To Male NPT Thread

Part No.	Tube O.D. D	T * (NPT)	d Min	Width Across Flat		A	B	I	L	L <sub>1</sub>
				h	H					
SFBT - 6M - 2N	6	1/8	4.8	12.70	14	15.3	17.7	19.6	27.0	19.0
SFBT - 6M - 4N	6	1/4	4.8	17.46	14	15.3	17.7	22.4	29.8	22.4
SFBT - 6M - 6N	6	3/8	4.8	20.63	14	15.3	17.7	24.4	31.7	22.4
SFBT - 6M - 8N	6	1/2	4.8	25.40	14	15.3	17.7	27.2	34.5	28.4
SFBT - 8M - 2N	8	1/8	6.4	15.87	16	16.2	18.6	22.4	29.9	19.0
SFBT - 8M - 4N	8	1/4	6.4	17.46	16	16.2	18.6	23.1	30.6	22.4
SFBT - 8M - 6N	8	3/8	6.4	20.63	16	16.2	18.6	25.2	32.4	22.4
SFBT - 8M - 8N	8	1/2	6.4	25.40	16	16.2	18.6	28.0	35.2	28.4
SFBT - 10M - 4N	10	1/4	7.9	20.63	19	17.2	19.5	25.9	33.5	22.4
SFBT - 10M - 6N	10	3/8	7.9	20.63	19	17.2	19.5	25.9	33.3	22.4
SFBT - 10M - 8N	10	1/2	9.5	25.40	19	17.2	19.5	26.2	33.6	22.4
SFBT - 12M - 4N	12	1/4	9.5	20.63	22	22.8	22.0	25.9	36.0	22.4
SFBT - 12M - 6N	12	3/8	9.5	20.63	22	22.8	22.0	25.9	36.0	22.4
SFBT - 12M - 8N	12	1/2	9.5	25.40	22	22.8	22.0	29.7	40.0	28.4
SFBT - 16M - 8N	16	1/2	12.7	25.40	25	24.4	22.0	28.7	38.8	28.4

\* ISO Tapered Threads are available upon request

\* All dimensions in millimeters unless specified as "inch". Dimension are for reference only, subject to change



## SFRT

### Female Run Tee

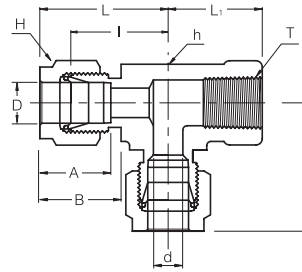

### Connects Fractional Tubes To Male NPT Thread

Part No.	Tube O.D. D (inch)	T * (NPT)	d Min	Width Across Flat		A	B	I	L	L <sub>1</sub>
				h (inch)	H (inch)					
SFRT - 2 - 2N	1/8	1/8	2.28	1/2	7/16	12.70	15.24	18.03	24.63	19.05
SFRT - 4 - 2N	1/4	1/8	4.82	1/2	9/16	15.24	17.78	19.55	26.92	19.05
SFRT - 4 - 4N	1/4	1/4	4.82	11/16	9/16	15.24	17.78	22.35	29.71	22.35
SFRT - 6 - 4N	3/8	1/4	7.11	11/16	11/16	16.76	19.30	23.87	31.24	22.35
SFRT - 8 - 6N	1/2	3/8	10.41	13/16	7/8	22.86	21.84	25.90	36.06	22.35
SFRT - 8 - 8N	1/2	1/2	10.41	1	7/8	22.86	21.84	28.70	39.87	28.44
SFRT - 12 - 12N	3/4	3/4	15.74	1-3/8	1-1/8	24.38	21.84	34.54	44.70	31.75
SFRT - 16 - 12N	1	3/4	22.35	1-3/8	1-1/2	31.24	26.41	36.83	49.02	31.75
SFRT - 16 - 16N	1	1	22.35	1-11/16	1-1/2	31.24	26.41	41.40	53.59	38.10

\* ISO Tapered Threads are available upon request

### Connects Metric Tubes To Male NPT Thread

Part No.	Tube O.D. D	T * (NPT)	d Min	Width Across Flat		A	B	I	L	L <sub>1</sub>
				h	H					
SFRT - 6M - 2N	6	1/8	4.8	12.70	14	15.3	17.7	19.6	27.0	19.0
SFRT - 6M - 4N	6	1/4	4.8	17.46	14	15.3	17.7	22.4	29.8	22.4
SFRT - 6M - 8N	6	1/2	4.8	25.40	14	15.3	17.7	27.2	34.5	28.4
SFRT - 8M - 2N	8	1/8	6.4	15.87	16	16.2	18.6	22.4	29.9	19.0
SFRT - 8M - 4N	8	1/4	6.4	17.46	16	16.2	18.6	23.1	30.6	22.4
SFRT - 8M - 6N	8	3/8	6.4	20.63	16	16.2	18.6	25.2	32.4	22.4
SFRT - 8M - 8N	8	1/2	6.4	25.40	16	16.2	18.6	28.0	35.2	28.4
SFRT - 12M - 4N	12	1/4	9.5	20.63	22	22.8	22.0	25.9	33.5	22.4
SFRT - 12M - 6N	12	3/8	9.5	20.63	22	22.8	22.0	25.9	36.0	22.4
SFRT - 12M - 8N	12	1/2	9.5	25.40	22	22.8	22.0	29.7	40.0	28.4
SFRT - 16M - 8N	16	1/2	12.7	25.40	25	24.4	22.0	29.7	39.8	28.4

\* ISO Tapered Threads are available upon request

# SUC

## Union Cross

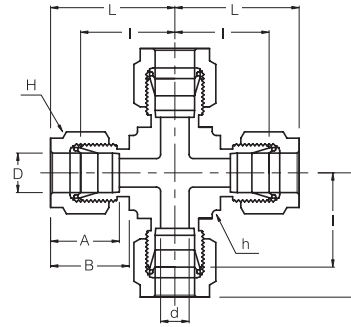

### Connects Fractional Tubes

Part No.	Tube O.D. D (inch)	d Min	Width Across Flat		A	B	I	L
			h (inch)	H (inch)				
SUC - 1	1/16	1.27	3/8	5/16	8.63	10.92	14.00	18.03
SUC - 2	1/8	2.28	3/8	7/16	12.70	15.24	15.74	22.35
SUC - 3	3/16	3.04	1/2	1/2	13.71	16.00	18.54	25.14
SUC - 4	1/4	4.82	1/2	9/16	15.24	17.78	19.55	26.92
SUC - 5	5/16	6.35	5/8	5/8	16.25	18.54	22.35	29.71
SUC - 6	3/8	7.11	5/8	11/16	16.76	19.30	23.11	30.48
SUC - 8	1/2	10.41	13/16	7/8	22.86	21.84	25.90	36.06
SUC - 10	5/8	12.70	15/16	1	24.38	21.84	28.70	38.80
SUC - 12	3/4	15.74	1	1-1/8	24.38	21.84	29.71	39.87
SUC - 14	7/8	18.28	1-3/8	1-1/4	25.90	21.84	34.54	44.70
SUC - 16	1	22.35	1-3/8	1-1/2	31.24	26.41	36.83	49.02

### Connects Metric Tubes

Part No.	Tube O.D. D	d Min	Width Across Flat		A	B	I	L
			h	H				
SUC - 3M	3	2.4	9.5	12	12.9	15.3	15.7	22.3
SUC - 6M	6	4.8	12.7	14	15.3	17.7	19.6	27.0
SUC - 8M	8	6.4	15.9	16	16.2	18.6	22.4	29.9
SUC - 10M	10	7.9	20.6	19	17.2	19.5	25.9	33.5
SUC - 12M	12	9.5	20.6	22	22.8	22.0	25.9	36.0
SUC - 16M	16	12.7	23.8	25	24.4	22.0	26.9	37.0
SUC - 18M	18	15.1	25.4	30	24.4	22.0	28.2	38.3
SUC - 20M	20	15.9	34.9	32	26.0	22.0	34.5	44.6
SUC - 25M	25	21.8	34.9	38	31.3	26.5	36.8	49.1

\* All dimensions in millimeters unless specified as "inch". Dimension are for reference only, subject to change

# SR Reducer

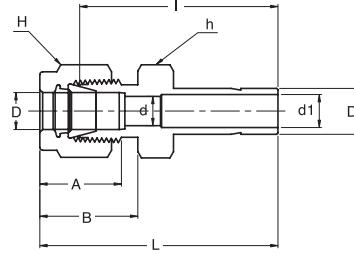

## Connects Fractional Tubes To Fractional SUPERLOK® Port

Part No.	Tube O.D.		d Min	d1 Min	Width Across Flat		A	B	I	L
	D (inch)	D1 (inch)			h (inch)	H (inch)				
SR - 2 - 1	1/8	1/16	2.28	0.8	7/16	7/16	12.70	15.24	22.35	28.95
SR - 2 - 2	1/8	1/8	2.28	2.1	7/16	7/16	12.70	15.24	26.92	33.52
SR - 2 - 3	1/8	3/16	2.28	3.0	7/16	7/16	12.70	15.24	27.68	34.29
SR - 2 - 4	1/8	1/16	2.28	4.4	7/16	7/16	12.70	15.24	29.46	36.06
SR - 2 - 6	1/8	1/16	2.28	6.9	7/16	7/16	12.70	15.24	30.98	37.59
SR - 2 - 8	1/8	1/2	2.28	9.4	9/16	7/16	12.70	15.24	37.59	44.19
SR - 3 - 2	3/16	1/8	3.04	2.1	7/16	1/2	13.71	16.00	28.19	34.79
SR - 3 - 4	3/16	1/4	3.04	4.4	7/16	1/2	13.71	16.00	30.48	37.08
SR - 4 - 2	1/4	1/8	4.83	2.1	1/2	9/16	15.24	17.78	29.46	36.83
SR - 4 - 3	1/4	3/16	4.83	3.0	1/2	9/16	15.24	17.78	30.22	37.59
SR - 4 - 4	1/4	1/4	4.83	4.4	1/2	9/16	15.24	17.78	31.75	39.11
SR - 4 - 5	1/4	5/16	4.83	5.6	1/2	9/16	15.24	17.78	32.51	39.87
SR - 4 - 6	1/4	3/8	4.83	6.9	1/2	9/16	15.24	17.78	33.27	40.64
SR - 4 - 8	1/4	1/2	4.83	9.4	9/16	9/16	15.24	17.78	38.86	46.22
SR - 4 - 10	1/4	5/8	4.83	12.0	11/16	9/16	15.24	17.78	40.64	48.00
SR - 4 - 12	1/4	3/4	4.83	14.8	13/16	9/16	15.24	17.78	41.40	47.75
SR - 5 - 6	5/16	3/8	6.35	6.9	9/16	5/8	16.25	18.54	34.54	41.91
SR - 5 - 8	5/16	1/2	6.35	9.4	9/16	5/8	16.25	18.54	40.13	47.49
SR - 6 - 4	3/8	1/4	7.11	4.4	5/8	11/16	16.76	19.30	34.03	41.40
SR - 6 - 6	3/8	3/8	7.11	6.9	5/8	11/16	16.76	19.30	35.81	43.18
SR - 6 - 8	3/8	1/2	7.11	9.4	5/8	11/16	16.76	19.30	41.14	48.51
SR - 6 - 10	3/8	5/8	7.11	12.0	11/16	11/16	16.76	19.30	42.92	50.29
SR - 6 - 12	3/8	3/4	7.11	14.8	13/16	11/16	16.76	19.30	42.92	50.29
SR - 8 - 4	1/2	1/4	10.41	4.4	13/16	7/8	22.86	21.84	34.79	44.95
SR - 8 - 6	1/2	3/8	10.41	6.9	13/16	7/8	22.86	21.84	36.57	46.73
SR - 8 - 8	1/2	1/2	10.41	9.4	13/16	7/8	22.86	21.84	42.16	52.32
SR - 8 - 10	1/2	5/8	10.41	12.0	13/16	7/8	22.86	21.84	43.68	53.84
SR - 8 - 12	1/2	3/4	10.41	14.8	13/16	7/8	22.86	21.84	43.68	53.84
SR - 8 - 16	1/2	1	10.41	20.4	1-1/16	7/8	22.86	21.84	50.03	60.19
SR - 10 - 12	5/8	3/4	12.70	14.8	15/16	1	24.38	21.84	44.45	54.61
SR - 10 - 14	5/8	7/8	12.70	17.0	15/16	1	24.38	21.84	45.97	56.13
SR - 10 - 16	5/8	1	12.70	20.4	1-1/16	1	24.38	21.84	50.80	60.96
SR - 12 - 8	3/4	1/2	15.74	9.4	1-1/16	1-1/8	24.38	21.84	44.45	54.61
SR - 12 - 16	3/4	1	15.74	20.4	1-1/16	1-1/8	24.38	21.84	52.32	62.48

\* Fractional Tube to Metric SUPERLOK port are available upon request

\* All dimensions in millimeters unless specified as "inch". Dimension are for reference only, subject to change

# SR Reducer

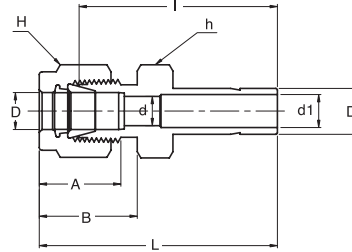
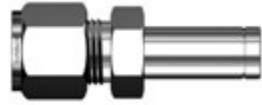

## Connects Metric Tubes To Metric SUPERLOK® Port

Part No.	Tube O.D.		d Min	d1 Min	Width Across Flat		A	B	I	L
	D	D1			h	H				
SR - 3M - 4M	3	4	2.4	2.2	12	12	12.9	15.3	28.4	35.0
SR - 3M - 6M	3	6	2.4	4.1	12	12	12.9	15.3	29.5	36.1
SR - 3M - 10M	3	10	2.4	7.1	14	12	12.9	15.3	31.8	38.4
SR - 4M - 6M	4	6	2.4	4.1	12	12	13.7	16.1	30.5	37.1
SR - 6M - 3M	6	3	4.8	1.8	14	14	15.3	17.7	29.5	36.9
SR - 6M - 8M	6	8	4.8	5.6	14	14	15.3	17.7	32.5	39.9
SR - 6M - 10M	6	10	4.8	7.1	14	14	15.3	17.7	33.3	40.7
SR - 6M - 12M	6	12	4.8	8.8	14	14	15.3	17.7	38.9	46.3
SR - 8M - 6M	8	6	6.4	4.1	15	16	16.2	18.6	32.8	40.3
SR - 8M - 10M	8	10	6.4	7.1	15	16	16.2	18.6	34.5	42.0
SR - 8M - 12M	8	12	6.4	8.8	15	16	16.2	18.6	40.1	47.6
SR - 10M - 6M	10	6	7.9	4.1	18	19	17.2	19.5	34.8	42.4
SR - 10M - 8M	10	8	7.9	5.6	18	19	17.2	19.5	35.8	43.4
SR - 10M - 12M	10	12	7.9	8.8	18	19	17.2	19.5	42.2	49.8
SR - 10M - 15M	10	15	7.9	11.2	18	19	17.2	19.5	43.7	51.3
SR - 10M - 18M	10	18	7.9	13.9	22	19	17.2	19.5	43.7	51.3
SR - 12M - 6M	12	6	9.5	4.1	22	22	22.8	22.0	34.8	44.9
SR - 12M - 8M	12	8	9.5	5.6	22	22	22.8	22.0	35.8	45.9
SR - 12M - 10M	12	10	9.5	7.1	22	22	22.8	22.0	36.6	46.7
SR - 12M - 16M	12	16	9.5	12.0	22	22	22.8	22.0	43.7	53.8
SR - 12M - 18M	12	18	9.5	13.9	22	22	22.8	22.0	43.7	53.8
SR - 12M - 20M	12	20	9.5	15.5	22	22	22.8	22.0	46.0	56.1
SR - 12M - 22M	12	22	9.5	17.9	24	22	22.8	22.0	46.0	56.1
SR - 12M - 25M	12	25	9.5	19.9	27	22	22.8	22.0	52.3	62.4
SR - 16M - 12M	16	12	12.7	8.8	27	25	24.4	22.0	42.9	53.0
SR - 18M - 12M	18	12	15.1	8.8	27	30	24.4	22.0	44.5	54.6
SR - 18M - 16M	18	16	15.1	12.0	27	30	24.4	22.0	46.0	56.1
SR - 18M - 20M	18	20	15.1	15.5	27	30	24.4	22.0	47.5	57.6
SR - 18M - 22M	18	22	15.1	17.9	30	30	24.4	22.0	47.5	57.6
SR - 18M - 25M	18	25	15.1	19.9	30	30	24.4	22.0	52.3	62.4
SR - 20M - 16M	20	16	15.9	12.0	30	32	26.0	22.0	47.8	57.9
SR - 20M - 18M	20	18	15.9	13.9	30	32	26.0	22.0	47.8	57.9
SR - 20M - 22M	20	22	15.9	17.9	30	32	26.0	22.0	49.3	59.4
SR - 20M - 25M	20	25	15.9	19.9	30	32	26.0	22.0	54.1	64.2
SR - 22M - 18M	22	18	18.3	13.9	30	32	26.0	22.0	47.8	57.9
SR - 22M - 20M	22	20	18.3	15.5	30	32	26.0	22.0	49.3	59.4
SR - 22M - 25M	22	25	18.3	19.9	30	32	26.0	22.0	54.1	64.2
SR - 25M - 18M	25	18	21.8	13.9	35	38	31.3	26.5	50.8	63.1
SR - 25M - 20M	25	20	21.8	15.5	35	38	31.3	26.5	52.3	64.6

\* All dimensions in millimeters unless specified as "inch". Dimension are for reference only, subject to change

## SR Reducer

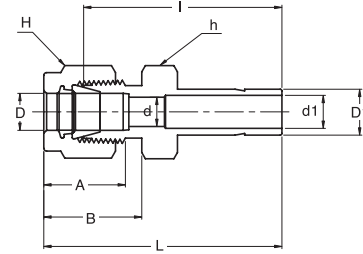

Connects Metric Tubes To Fractional **SUPERLOK®** Port

Part No.	Tube O.D.		d Min	d1 Min	Width Across Flat		A	B	I	L
	D	D <sub>1</sub> (inch)			h	H				
SR - 3M - 2	3	1/8	2.4	2.1	12	12	12.9	15.3	26.9	33.5
SR - 3M - 4	3	1/4	2.4	4.4	12	12	12.9	15.3	29.5	36.1
SR - 6M - 4	6	1/4	4.8	4.4	14	14	15.3	17.7	31.8	39.2
SR - 6M - 5	6	5/16	4.8	5.6	14	14	15.3	17.7	32.5	39.9
SR - 6M - 6	6	3/8	4.8	6.9	14	14	15.3	17.7	33.3	40.7
SR - 6M - 8	6	1/2	4.8	9.4	14	14	15.3	17.7	38.9	46.3
SR - 8M - 6	8	3/8	6.4	6.9	15	16	16.2	18.6	34.5	42.0
SR - 8M - 8	8	1/2	6.4	9.4	15	16	16.2	18.6	40.1	47.6
SR - 10M - 6	10	3/8	7.9	6.9	18	19	17.2	19.5	36.6	44.2
SR - 10M - 8	10	1/2	7.9	9.4	18	19	17.2	19.5	42.2	49.8
SR - 12M - 8	12	1/2	9.5	9.4	22	22	22.8	22.0	42.2	52.3
SR - 12M - 12	12	3/4	9.5	14.8	22	22	22.8	22.0	43.7	53.8
SR - 18M - 12	18	3/4	15.1	14.8	27	30	24.4	22.0	46.0	56.1
SR - 18M - 16	18	1	15.1	20.4	27	30	24.4	22.0	52.3	62.4

## SRB Bulkhead Reducer

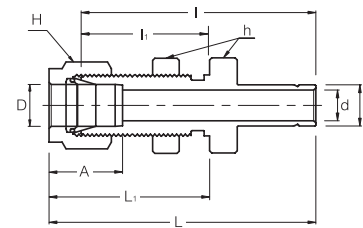
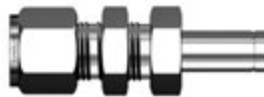

Connects Fractional Tubes To Fractional **SUPERLOK®** Port

Part No.	Tube O.D. D (inch)	d Min	Width Across Flat		A	I	I <sub>1</sub>	L	L <sub>1</sub>	Panel Hole Drill Size	Panel Max. Thickness
			h (inch)	H (inch)							
SRB - 2 - 2	1/8	2.1	1/2	7/16	12.70	42.92	24.63	49.53	31.24	8.33	12.70
SRB - 4 - 4	1/4	4.4	5/8	9/16	15.24	48.51	26.16	55.88	33.52	11.50	10.16
SRB - 6 - 6	3/8	6.9	3/4	11/16	16.76	53.84	29.46	61.21	36.83	14.68	11.17
SRB - 8 - 8	1/2	9.4	15/16	7/8	22.86	62.73	31.75	72.89	41.91	19.44	12.70
SRB - 10 - 10	5/8	12.0	1-1/16	1	24.38	65.02	32.51	75.18	42.67	22.62	12.70
SRB - 16 - 16	1	20.4	1-5/8	1-1/2	31.24	88.13	45.21	100.33	57.40	33.73	19.05

\* All dimensions in millimeters unless specified as "inch". Dimension are for reference only, subject to change

## SMA Male Adapter

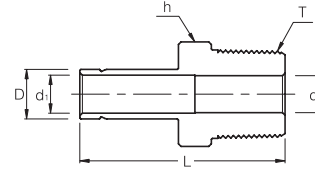

### Connects Fractional **SUPERLOK**® Port To Female NPT Thread

Part No.	Tube O.D. D (inch)	T* (NPT)	d (Min)	d <sub>1</sub>	Width Across Flat h (inch)	L
SMA - 2 - 2N	1/8	1/8	4.82	2.10	7/16	29.50
SMA - 2 - 4N	1/8	1/4	7.11	2.10	9/16	34.80
SMA - 3 - 2N	3/16	1/8	4.82	3.04	7/16	30.22
SMA - 3 - 4N	3/16	1/4	7.11	3.04	9/16	35.56
SMA - 4 - 2N	1/4	1/8	4.40	4.40	7/16	31.80
SMA - 4 - 4N	1/4	1/4	4.40	4.40	9/16	37.08
SMA - 4 - 6N	1/4	3/8	4.40	4.40	11/16	37.84
SMA - 4 - 8N	1/4	1/2	4.40	4.40	7/8	43.43
SMA - 5 - 2N	5/16	1/8	4.82	5.60	7/16	32.76
SMA - 5 - 4N	5/16	1/4	6.35	5.60	9/16	38.10
SMA - 6 - 2N	3/8	1/8	4.82	6.90	7/16	33.50
SMA - 6 - 4N	3/8	1/4	6.90	6.90	9/16	38.90
SMA - 6 - 6N	3/8	3/8	6.90	6.90	11/16	39.60
SMA - 6 - 8N	3/8	1/2	6.90	6.90	7/8	45.20
SMA - 8 - 4N	1/2	1/4	7.11	9.40	9/16	44.50
SMA - 8 - 6N	1/2	3/8	9.40	9.40	11/16	45.20
SMA - 8 - 8N	1/2	1/2	9.40	9.40	7/8	50.80
SMA - 10 - 6N	5/8	3/8	9.90	12.00	11/16	47.40
SMA - 10 - 8N	5/8	1/2	12.00	12.00	7/8	52.30
SMA - 10 - 12N	5/8	3/4	14.98	12.00	1-1/16	52.30
SMA - 12 - 8N	3/4	1/2	11.94	14.80	7/8	52.30
SMA - 12 - 12N	3/4	3/4	14.80	14.80	1-1/16	52.30
SMA - 12 - 16N	3/4	1	20.32	14.80	1-3/8	57.91
SMA - 14 - 12N	7/8	3/4	14.98	17.27	1-1/16	54.30
SMA - 16 - 12N	1	3/4	15.74	20.40	1-1/16	58.70
SMA - 16 - 16N	1	1	20.40	20.40	1-3/8	66.00

\* ISO Tapered Threads are available upon request

### Connects Metric **SUPERLOK**® Port To Female NPT Thread

Part No.	Tube O.D. D (inch)	T* (NPT)	d (Min)	d <sub>1</sub>	Width Across Flat h (inch)	L
SMA - 6M - 2N	6	1/8	4.1	4.1	12	32.8
SMA - 6M - 4N	6	1/4	4.1	4.1	14	38.1
SMA - 8M - 4N	8	1/4	5.6	5.6	14	39.1
SMA - 10M - 4N	10	1/4	7.1	7.1	14	39.9
SMA - 10M - 6N	10	3/8	7.1	7.1	18	40.6
SMA - 10M - 8N	10	1/2	11.9	7.1	22	46.2
SMA - 12M - 4N	12	1/4	7.1	8.8	16	46.5
SMA - 12M - 8N	12	1/2	11.9	8.8	22	52.0
SMA - 18M - 12N	18	3/4	15.9	13.9	27	54.8

\* ISO Tapered Threads are available upon request

\* All dimensions in millimeters unless specified as "inch". Dimension are for reference only, subject to change



# SFA

## Female Adapter

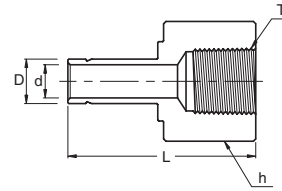

### Connects Fractional **SUPERLOK**® Port To Male NPT Thread

Part No.	Tube O.D. D (inch)	T* (NPT)	d (Min)	Width Across Flat h (inch)	L
SFA - 2 - 2N	1/8	1/8	2.10	9/16	31.50
SFA - 2 - 4N	1/8	1/4	2.10	3/4	35.30
SFA - 3 - 2N	3/16	1/8	3.04	9/16	32.00
SFA - 3 - 4N	3/16	1/4	3.04	3/4	35.81
SFA - 4 - 2N	1/4	1/8	4.40	9/16	33.02
SFA - 4 - 4N	1/4	1/4	4.40	3/4	37.10
SFA - 4 - 6N	1/4	3/8	4.40	7/8	39.37
SFA - 4 - 8N	1/4	1/2	4.40	1-1/16	45.50
SFA - 5 - 2N	5/16	1/8	5.60	9/16	34.29
SFA - 5 - 4N	5/16	1/4	5.60	3/4	37.59
SFA - 6 - 2N	3/8	1/8	6.90	9/16	34.29
SFA - 6 - 4N	3/8	1/4	6.90	3/4	38.10
SFA - 6 - 6N	3/8	3/8	6.90	7/8	40.38
SFA - 6 - 8N	3/8	1/2	6.90	1-1/16	46.73
SFA - 8 - 4N	1/2	1/4	9.40	3/4	43.43
SFA - 8 - 6N	1/2	3/8	9.40	7/8	45.46
SFA - 8 - 8N	1/2	1/2	9.40	1-1/16	51.80
SFA - 10 - 6N	5/8	3/8	12.00	7/8	48.26
SFA - 10 - 8N	5/8	1/2	12.00	1-1/16	53.08
SFA - 12 - 8N	3/4	1/2	14.80	1-1/16	52.83
SFA - 12 - 12N	3/4	3/4	14.80	1-5/16	54.86
SFA - 12 - 16N	3/4	1	14.80	1-5/8	58.42
SFA - 14 - 12N	7/8	3/4	17.27	1-5/16	57.15
SFA - 16 - 12N	1	3/4	20.40	1-5/16	60.70
SFA - 16 - 16N	1	1	20.40	1-5/8	64.26

\* ISO Tapered or ISO Parallel Threads are available upon request

### Connects Metric **SUPERLOK**® Port To Male NPT Thread

Part No.	Tube O.D. D (inch)	T* (NPT)	d (Min)	Width Across Flat h (inch)	L
SFA - 3M - 2N	3	1/8	1.8	14	31.2
SFA - 6M - 2N	6	1/8	4.1	14	32.5
SFA - 6M - 4N	6	1/4	4.1	19	37.1
SFA - 8M - 4N	8	1/4	5.6	19	37.6
SFA - 10M - 4N	10	1/4	7.1	19	38.1
SFA - 10M - 6N	10	3/8	7.1	22	40.1
SFA - 10M - 8N	10	1/2	7.1	27	46.5
SFA - 12M - 4N	12	1/4	8.8	19	43.7
SFA - 12M - 6N	12	3/8	8.8	22	46.0
SFA - 12M - 8N	12	1/2	8.8	27	52.3
SFA - 18M - 12N	18	3/4	13.9	32	54.8

\* ISO Tapered or ISO Parallel Threads are available upon request

\* All dimensions in millimeters unless specified as "inch". Dimension are for reference only, subject to change

## SUPERLOK<sup>®</sup> Adapter Solves Alignment Problems

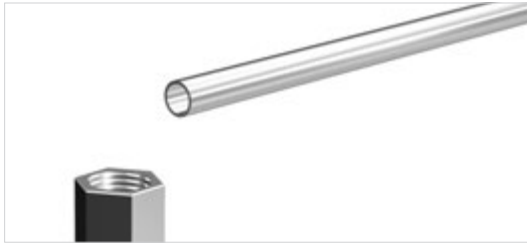

1. Required installation is to connect tubing in direction shown, to a female port.



3. Connect Male Tube adapter to female port.



2. With pipe connection tight, the male elbow is pointing in the wrong direction for desired tubing run.



4. Connect union elbow to adapter by tightening SUPERLOK connection with wrench while holding elbow pointing in desired direction. Then insert tubing into the other end of the Union Elbow and make up fitting.

## SPC Port Connector



### Connects Fractional SUPERLOK<sup>®</sup> Ports

Part No.	Tube O.D. D (inch)	d (Min)	E	L
SPC - 2	1/8	2.1	6.09	22.35
SPC - 4	1/4	4.4	9.39	25.30
SPC - 5	5/16	5.6	10.92	25.90
SPC - 6	3/8	6.9	12.70	26.70
SPC - 8	1/2	9.4	15.74	35.81
SPC - 12	3/4	14.8	22.09	38.10
SPC - 16	1	20.4	28.44	48.00

### Connects Metric SUPERLOK<sup>®</sup> Ports

Part No.	Tube O.D. D (inch)	d (Min)	E	L
SPC - 3M	3	1.9	6.0	22.2
SPC - 6M	6	4.1	9.0	24.6
SPC - 8M	8	5.6	11.0	28.5
SPC - 10M	10	7.1	13.1	26.1
SPC - 12M	12	8.8	15.0	35.8
SPC - 16M	16	12.0	19.0	37.4

\* All dimensions in millimeters unless specified as "inch". Dimension are for reference only, subject to change

## SRPC

### Reducing Port Connector

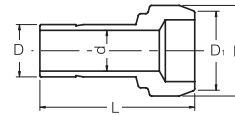

#### Connects Fractional **SUPERLOK**® Port To Male AN

Part No.	Tube O.D. D <sub>1</sub> (inch)	Reduced Tube O.D. D (inch)	d	E	l	l <sub>1</sub>	L
SRPC - 2 - 1	1/8	1/16	0.76	6.09	8.63	2.03	17.27
SRPC - 4 - 1	1/4	1/16	0.76	9.39	8.63	3.55	18.03
SRPC - 4 - 2	1/4	1/8	2.10	9.39	13.46	3.30	22.60
SRPC - 6 - 2	3/8	1/8	2.10	12.70	13.46	3.81	23.11
SRPC - 6 - 4	3/8	1/4	4.40	12.70	15.74	3.30	24.89
SRPC - 8 - 4	1/2	1/4	4.40	15.74	15.74	3.81	29.21
SRPC - 8 - 6	1/2	3/8	6.90	15.74	17.52	3.30	30.48
SRPC - 12 - 8	3/4	1/2	9.40	22.09	24.38	3.81	37.84
SRPC - 16 - 8	1	1/2	9.40	28.44	24.38	4.82	42.67
SRPC - 16 - 12	1	3/4	14.80	28.44	25.90	4.06	43.43

## Installation Instructions

### Port Connector

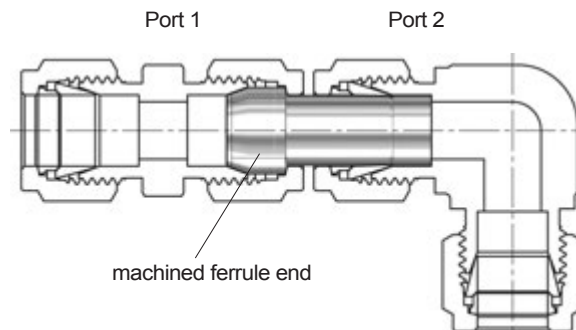

- Remove nut and ferrules from the first of two SUPERLOK ports to be connected.
- Slip nut (no ferrules) over machined ferrule end of port connector.
- Insert port connector into SUPERLOK port 1 and snug by hand. Tighten with wrench 1/4 turn only.  
For 1/8, 3/16 in., 2, 3, and 4mm tube fittings, tighten only 1/8 turn. Subsequent connections are made by tightening slightly with a wrench after tightening by hand.
- Insert other end of port connector into SUPERLOK port 2 and tighten nut 1-1/4 turns from finger-tight.  
For 1/16, 1/8, 3/16 in., 2, 3, and 4mm tube fittings, only 3/4 turn from finger-tight is necessary.

\* All dimensions in millimeters unless specified as "inch". Dimension are for reference only, subject to change

## SFTC

### Lap Joint Flange Tubes Connector

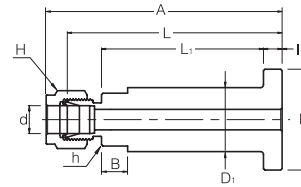

#### Connects Fractional Tubes

Part No.	Tube Size (inch)	Flange Seat	Dimensions									
			A	B	L <sub>1</sub>	L	I	h (inch)	H (inch)	D	D <sub>1</sub>	d (Min)
SFTC - 4 - SM	1/4	SM	80.8	8.9	56.5	74.9	6.5	11/16	9/16	34.5	21.1	4.8
SFTC - 4 - SR	1/4	SR	80.8	8.9	56.5	74.9	6.5	11/16	9/16	34.5	21.1	4.8
SFTC - 6 - SM	3/8	SM	82.3	8.9	56.5	74.9	6.5	11/16	11/16	34.5	21.1	7.1
SFTC - 6 - SR	3/8	SR	82.3	8.9	56.5	74.9	6.5	11/16	11/16	34.5	21.1	7.1
SFTC - 8 - SM	1/2	SM	85.1	8.9	56.5	74.9	6.5	3/4	7/8	34.5	21.1	10.4
SFTC - 8 - SR	1/2	SR	85.1	8.9	56.5	74.9	6.5	3/4	7/8	34.5	21.1	10.4

Lap joint flange tube connector provides easy joint between process lines and instruments designed for use with 1/2in Lap joint flanges to ANSI B 16.5 or BS 1560

#### Flange Seal Finish

Two surface finishes, smooth or serrated, are available on the sealing surface of the stub end.



Smooth  
Identifier : SM  
Ra 3.2 ~ 6.3  
micrometer



Serrated  
Identifier : SR  
Ra 6.3 ~ 12.5  
micrometer

\*Note : GROOVE identifies serrated surface finish

## SAF

### An Flare

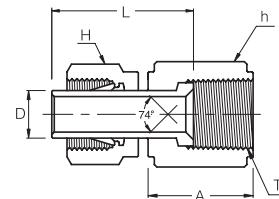

#### Connects Fractional **SUPERLOK**® Port To Male AN

Part No.	Tube O.D. D (inch)	AN Tube Flare Size (inch)	Straight Thread T (U)	Width Across Flat		A	L
				h (inch)	H (inch)		
SAF - 2 - 2U	1/8	1/8	5/16-24	3/8	7/16	13.71	18.54
SAF - 2 - 4U	1/8	1/4	7/16-20	9/16	7/16	15.74	19.05
SAF - 4 - 4U	1/4	1/4	7/16-20	9/16	9/16	15.74	23.20
SAF - 6 - 6U	3/8	3/8	9/16-18	11/16	11/16	18.28	27.30
SAF - 8 - 8U	1/2	1/2	3/4-16	7/8	7/8	21.59	34.50

\* All dimensions in millimeters unless specified as "inch". Dimension are for reference only, subject to change

## SAU An Union

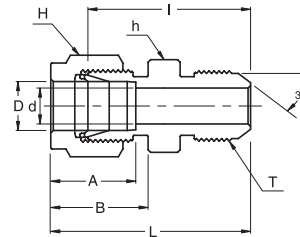

### Connects Fractional Tubes To An Flared Tubes

Part No.	Tube O.D. D (inch)	AN Tube Flare Size (inch)	Straight Thread T (U)	d Min	Width Across Flat		A	B	I	L
					h (inch)	H (inch)				
SAU - 2 - 2U	1/8	1/8	5/16-24	1.52	7/16	7/16	12.70	15.24	25.65	32.25
SAU - 2 - 4U	1/8	1/4	7/16-20	2.28	1/2	7/16	12.70	15.24	28.44	35.05
SAU - 4 - 4U	1/4	1/4	7/16-20	4.31	1/2	9/16	15.24	17.78	30.22	37.59
SAU - 5 - 5U	5/16	5/16	1/2-20	5.84	9/16	5/8	16.25	18.54	30.98	38.35
SAU - 6 - 4U	3/8	1/4	7/16-20	4.31	5/8	11/16	16.76	19.30	32.25	39.62
SAU - 6 - 6U	3/8	3/8	9/16-18	7.11	5/8	11/16	16.76	19.30	32.25	39.62
SAU - 8 - 8U	1/2	1/2	3/4-16	9.90	13/16	7/8	22.86	21.84	35.81	45.97
SAU - 12 - 12U	3/4	3/4	1-1/16-12	15.49	1-1/8	1-1/8	24.38	21.84	43.18	53.34
SAU - 16 - 16U	1	1	1-5/16-12	21.33	1-3/8	1-1/2	31.24	26.41	49.27	61.46

## SAA An Adapter

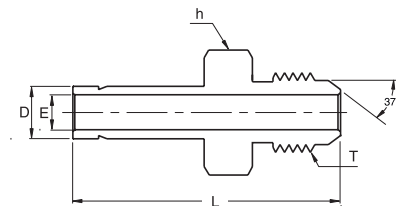

### Connects Fractional SUPERLOK® Port To AN Flared Tubes

Part No.	Tube O.D. D (inch)	AN Tube Flare Size (inch)	Straight Thread T (U)	Width Across Flat h (inch)	E	L
SAA - 4 - 4U	1/4	1/4	7/16-20	1/2	4.40	37.08
SAA - 6 - 4U	3/8	1/4	7/16-20	1/2	6.90	38.86
SAA - 6 - 6U	3/8	3/8	9/16-18	5/8	6.90	39.62
SAA - 8 - 8U	1/2	1/2	3/4-16	13/16	9.40	48.51
SAA - 12 - 12U	3/4	3/4	1-1/16-12	1-1/8	14.80	56.13
SAA - 16 - 16U	1	1	1-5/16-12	1-3/8	20.40	65.53

\* All dimensions in millimeters unless specified as "inch". Dimension are for reference only, subject to change

## SOSC

### Straight Thread Connector

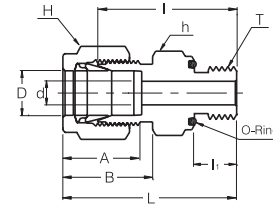

#### Connects Fractional Tube To Female Straight Thread

Part No.	Tube O.D. D (inch)	Straight Thread T (U)	d Min	Width Across Flat		A	B	I	I <sub>1</sub>	L	O-Ring Uniform Size Number
				h (inch)	H (inch)						
SOSC - 2 - 2U	1/8	5/16-24	2.28	9/16	7/16	12.70	15.24	26.16	8.63	32.76	-011
SOSC - 3 - 3U	3/16	3/8-24	3.05	5/8	1/2	13.71	16.00	27.68	9.65	34.29	-012
SOSC - 4 - 4U	1/4	7/16-20	4.82	3/4	9/16	15.24	17.78	30.98	10.41	38.35	-111
SOSC - 5 - 5U	5/16	1/2-20	6.35	7/8	5/8	16.25	18.54	33.27	11.17	40.64	-112
SOSC - 6 - 6U	3/8	9/16-18	7.11	15/16	11/16	16.76	19.30	35.05	11.93	42.41	-114
SOSC - 8 - 8U	1/2	3/4-16	10.41	1-1/8	7/8	22.86	21.84	35.81	11.93	45.97	-116
SOSC -12 - 12U	3/4	1-1/16-12	15.75	1-1/2	1-1/8	24.38	21.84	42.16	14.22	52.32	-215
SOSC -16 - 16U	1	1-5/16-12	22.35	1-3/4	1-1/2	31.24	26.41	45.97	14.22	58.16	-219

## SOPC

### O-Seal Pipe Thread Connector

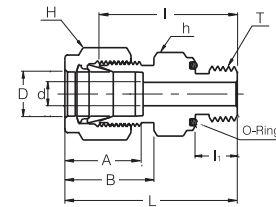

#### Connects Fractional Tube To Female NPT Thread

Part No.	Tube O.D. D (inch)	T* (NPT)	d Min	Width Across Flat		A	B	I	I <sub>1</sub>	L	O-Ring Uniform Size Number
				h (inch)	H (inch)						
SOPC - 2 - 2N	1/8	1/8	2.28	3/4	7/16	12.70	15.24	26.16	7.11	32.76	-111
SOPC - 4 - 2N	1/4	1/8	4.82	3/4	9/16	15.24	17.78	27.68	7.11	35.05	-111
SOPC - 4 - 4N	1/4	1/4	4.82	15/16	9/16	15.24	17.78	30.98	9.65	38.35	-113
SOPC - 6 - 4N	3/8	1/4	7.11	15/16	11/16	16.76	19.30	32.51	9.65	39.87	-113
SOPC - 6 - 6N	3/8	3/8	7.11	1-1/8	11/16	16.76	19.30	34.03	10.41	41.40	-116
SOPC - 6 - 8N	3/8	1/2	7.11	1-5/16	11/16	16.76	19.30	39.62	13.46	46.99	-212
SOPC - 8 - 8N	1/2	1/2	10.41	1-5/16	7/8	22.86	21.84	39.62	13.46	49.78	-212

\* All dimensions in millimeters unless specified as "inch". Dimension are for reference only, subject to change

# SSMC

## SAE/MS Male Connector

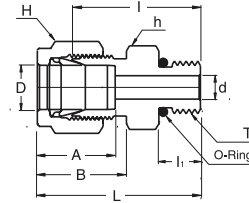
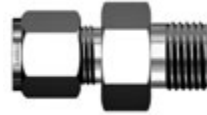

### Connects Fractional Tubes To SAE/MS Straight Thread Boss

Part No.	Tube O.D. D (inch)	Straight Thread T (U)	d Min	Width Across Flat		A	B	I	I <sub>1</sub>	L	O-Ring Uniform Size Number
				h (inch)	H (inch)						
SSMC - 2 - 2U	1/8	5/16-24	2.28	7/16	7/16	12.70	15.24	23.36	7.62	29.97	3-902
SSMC - 4 - 4U	1/4	7/16-20	4.82	9/16	9/16	15.24	17.78	26.67	9.14	34.03	3-904
SSMC - 4 - 6U	1/4	9/16-18	4.82	11/16	9/16	15.24	17.78	28.19	9.90	35.56	3-906
SSMC - 4 - 8U	1/4	3/4-16	4.82	7/8	9/16	15.24	17.78	30.22	11.17	37.59	3-908
SSMC - 4 - 10U	1/4	7/8-14	4.82	1	9/16	15.24	17.78	33.27	12.70	40.64	3-910
SSMC - 5 - 5U	5/16	1/2-20	6.35	5/8	5/8	16.25	18.54	27.43	9.14	34.79	3-905
SSMC - 6 - 4U	3/8	7/16-20	5.08	5/8	11/16	16.76	19.30	28.19	9.14	35.56	3-904
SSMC - 6 - 6U	3/8	9/16-18	7.11	11/16	11/16	16.76	19.30	29.71	9.90	37.08	3-906
SSMC - 6 - 8U	3/8	3/4-16	7.11	7/8	11/16	16.76	19.30	31.75	11.17	39.11	3-908
SSMC - 6 - 10U	3/8	7/8-14	7.11	1	11/16	16.76	19.30	34.79	12.70	42.16	3-910
SSMC - 8 - 6U	1/2	9/16-18	7.11	13/16	7/8	22.86	21.84	28.95	9.90	39.11	3-906
SSMC - 8 - 8U	1/2	3/4-16	10.41	7/8	7/8	22.86	21.84	31.75	11.17	41.91	3-908
SSMC - 8 - 10U	1/2	7/8-14	10.41	1	7/8	22.86	21.84	34.79	12.70	44.95	3-910
SSMC - 8 - 12U	1/2	1-1/16-12	10.41	1-1/4	7/8	22.86	21.84	38.86	14.98	49.02	3-912
SSMC - 10 - 8U	5/8	3/4-16	10.66	15/16	1	24.38	21.84	31.75	11.17	41.91	3-908
SSMC - 10 - 10U	5/8	7/8-14	12.70	1	1	24.38	21.84	35.05	12.70	45.21	3-910
SSMC - 12 - 8U	3/4	3/4-16	10.66	1-1/16	1-1/8	24.38	21.84	35.81	11.17	45.97	3-908
SSMC - 12 - 12U	3/4	1-1/16-12	15.74	1-1/4	1-1/8	24.38	21.84	38.86	14.98	49.02	3-912
SSMC - 14 - 14U	7/8	1-3/16-12	18.28	1-3/8	1-1/4	25.90	21.84	38.86	14.98	49.02	3-914
SSMC - 16 - 12U	1	1-1/16-12	16.76	1-3/8	1-1/2	31.24	26.41	41.14	14.98	53.34	3-912
SSMC - 16 - 16U	1	1-5/16-12	22.35	1-1/2	1-1/2	31.24	26.41	42.16	14.98	54.35	3-916

\* All dimensions in millimeters unless specified as "inch". Dimension are for reference only, subject to change

## Mounting Dimensions for O-Seal Connectors

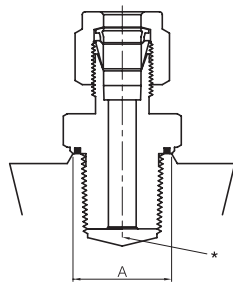

Figure 1

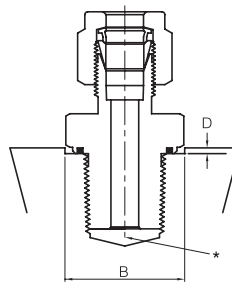

Figure 2

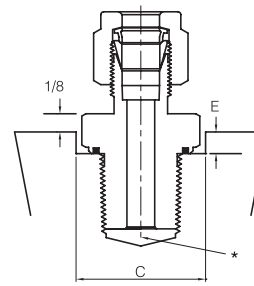

Figure 3

\*ALLOW CLEARANCE FOR FULL THREAD

### Installation Instructions

In order to prevent the leakage with Superlok O-Seal Fittings, the surface perpendicular to the axis of the thread should be flat. When installing an O-seal fitting, turn it until finger tight (the squeeze on O-ring can be felt during the last 1/4 turn). After finger tight installation, snug lightly with a wrench. When connecting the tubing to the Superlok connector, always use a back-up wrench on the O-seal fitting hex so it does not turn while the nut is being tightened. Also use a back-up wrench when disconnecting a tubing connection. For a raised surface, such as Figure 1, it is recommended that the flat surface have a diameter at least as large as dimension “A” for the various size O-seal fittings. This diameter is sufficient to allow metal-to-metal contact outside of the O-ring sealing diameter and to prevent O-ring extrusion at high pressure. Figure 2 is an O-seal fitting using with a counter bored or recessed hole. In this case, the diameter “B” is sufficient to allow the round shoulder of the O-seal to clear for proper installation. “D” gives the maximum depth that can be used with this diameter. Figure 3 shows the usage at deeper grooved or concaved area and “E” is the maximum depth that will allow a thin wrench (1/8”) to hold the O-seal fitting while the Superlok connection is made to the tubing. The diameter “C” is sufficient to allow the hex of the fitting to turn in the recessed hole.

Basic Ordering Number	Straight Thread	Pipe Thread	A Min. Dia.	B Min. Dia.	C Min. Dia.	D Min. Dia.	E Min. Dia.
SOSC - 1 - 2U	5/16-24	-	12.7	15.0	16.8	2.3	4.1
SOSC - 2 - 2U	5/16-24	-	12.7	15.0	16.8	2.3	5.6
SOPC - 2 - 2N	-	1/8 NPT	17.5	19.8	22.4	4.1	7.1
SOSC - 3 - 3U	3/8-24	-	14.2	16.8	19.1	2.3	5.6
SOSC - 4 - 4U	7/16-20	-	17.5	19.8	22.4	4.1	7.1
SOPC - 4 - 2N	-	1/8 NPT	17.5	19.8	22.4	4.1	7.1
SOPC - 4 - 4N	-	1/4 NPT	22.1	24.6	27.7	4.1	7.9
SOSC - 5 - 5U	1/2-20	-	19.1	23.1	26.2	4.1	7.9
SOSC - 6 - 6U	9/16-18	-	20.6	24.6	27.7	4.1	7.9
SOPC - 6 - 4N	-	1/4 NPT	22.1	24.6	27.7	4.1	7.9
SOPC - 6 - 6N	-	3/8 NPT	25.4	29.5	33.3	4.1	8.6
SOPC - 6 - 8N	-	1/2 NPT	31.0	34.0	38.9	5.6	11.2
SOSC - 8 - 8U	3/4-16	-	25.4	29.5	33.3	4.1	8.6
SOPC - 8 - 8N	-	1/2 NPT	31.0	34.0	38.9	5.6	11.2
SOSC - 12 - 12U	1-1/16-12	-	35.8	38.9	44.5	5.6	12.7
SOSC - 16 - 16U	1-5/16-12	-	42.9	45.2	51.6	5.6	14.2

Dimensions are for reference only and are subject to change.

\* All dimensions in millimeters unless specified as “inch”. Dimension are for reference only, subject to change



## SAE/MS Straight Thread Positionable Elbows and Tees



### Installation instructions

- 1 Lubricate O-ring with suitable lubricant for system fluid, environment and for the O-ring material. Viton® is standard - other materials are also available.
- 2 Turn the fittings into the straight thread boss until the metal backup washer contacts the face of the boss. At this moment, O-ring gets into inclined groove.
- 3 Until Superlok's end is oriented in the proper direction, position the fittings by turning them counter clockwise (no more than 1 turn).
- 4 Tighten the fittings with wrench and back up wrench until the washer contacts the mating surface and O-ring is compressed slightly.

※ Note: SAE/MS' POSITIONABLE TEE and ELBOWS are compatible with SAE J1926, MS16142, or o-ring female straight thread for JIS boss.

### O-Ring for SAE/MS Fittings Bosses

Thread size	Inside Dimension (mm)	Cross Section (mm)	O-Ring Size No.	Thread size	Inside Dimension (mm)	Cross Section (mm)	O-Ring Size No.
5/16-24	6.07	1.63	3-902	3/4-16	16.36	2.21	3-908
3/8-24	7.65	1.63	3-903	7/8-14	19.18	2.46	3-910
7/16-20	8.92	1.83	3-904	1-1/16-12	23.47	2.95	3-912
1/2-20	10.52	1.83	3-905	1-3/16-12	26.59	2.95	3-914
9/16-18	11.89	1.98	3-906	1-5/16-12	29.74	2.95	3-916

## SAE/MS Internal Straight Thread Boss

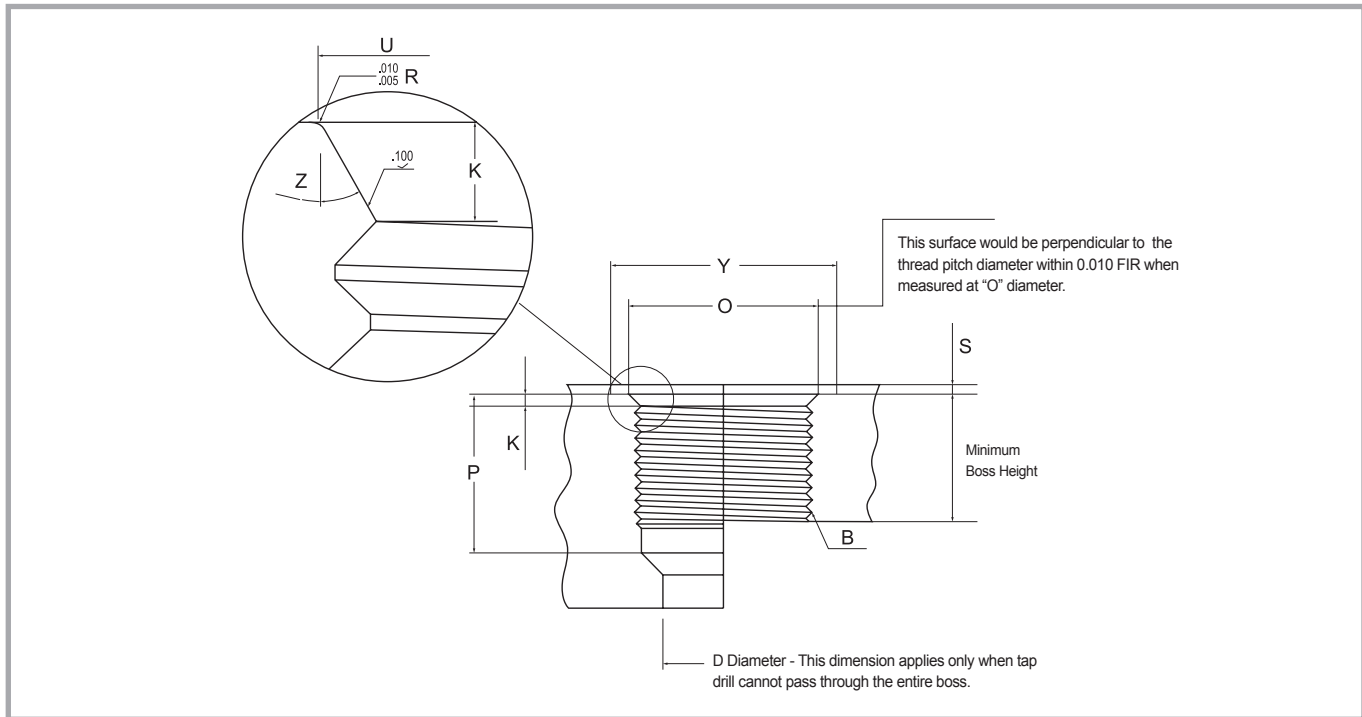

- O : This surface would be perpendicular to the thread pitch diameter within 0.010 FIR when measured at "O" diameter.
- D : This dimension applies only when tap drill cannot pass through the entire boss.

### Data for SAE/MS Straight Thread Boss

Nom. Tube.O.D	Thread Size	B / Straight Thread				D Dia	Full Thread Depth	K	O Dia	P <sup>①</sup>	S <sup>②③</sup>	U <sup>④</sup> Dia	Y <sup>⑤</sup> Dia	Z
		Pitch Dia		Minor Dia										
		Min	Max	Min	Max									
1/8	5/16 - 24	0.2854	0.2902	0.267	0.277	0.062	0.390	0.074	0.438	0.468	0.062	0.358	0.672	12
3/16	3/8 - 24	0.3479	0.3528	0.330	0.340	0.125	0.390	0.074	0.500	0.468	0.062	0.421	0.750	12
1/4	7/16 - 20	0.4050	0.4104	0.383	0.395	0.172	0.454	0.093	0.563	0.547	0.062	0.487	0.828	12
5/16	1/2 - 20	0.4675	0.4731	0.446	0.457	0.234	0.454	0.093	0.625	0.547	0.062	0.550	0.906	12
3/8	9/16 - 18	0.5624	0.5323	0.502	0.515	0.297	0.500	0.097	0.688	0.609	0.062	0.616	0.969	12
1/2	3/4 - 16	0.7094	0.7159	0.682	0.696	0.391	0.562	0.100	0.875	0.688	0.094	0.811	1.188	15
5/8	7/8 - 14	0.8286	0.8356	0.798	0.614	0.484	0.656	0.100	1.000	0.781	0.094	0.942	1.344	15
3/4	1 1/16 - 12	1.0084	1.0158	0.972	0.990	0.609	0.750	1.130	1.250	0.906	0.094	1.148	1.625	15
7/8	1 3/16 - 12	1.1334	1.1409	1.097	1.115	0.719	0.750	1.130	1.375	0.906	0.094	1.273	1.765	15
1	1 5/16 - 12	1.2584	1.2659	1.222	1.240	0.844	0.750	0.130	1.500	0.906	0.125	1.398	1.910	15
1 1/4	1 5/8 - 12	1.5709	1.5785	1.535	1.553	1.078	0.750	0.132	1.875	0.906	0.125	1.713	2.270	15
1 1/2	1 7/8 - 12	1.8209	1.8287	1.785	1.803	1.312	0.750	0.132	2.125	0.906	0.125	1.962	2.560	15
2	2 1/2 - 12	2.4459	2.4540	2.410	2.428	1.781	0.750	0.132	2.750	0.906	0.125	2.587	3.480	15

- ① Diameter U shall be concentric with thread pitch diameter within 0.005 full indicator reading (FIR) and shall be free from longitudinal and spiral tool marks. Annular tool marks shall be less than 100micro inches.
- ② This is the maximum recommended spotface depth to permit sufficient wrench grip for proper tightening of the fitting or locknut
- ③ If the surface of boss surface is machined, dimensions Y and S does not need to be applied.
- ④ Bottoming tap shall be used to satisfy the tap drill depth. Where standard taps are used, the drill depths must be increased accordingly

# SPWC

## Male Pipe Weld Connector

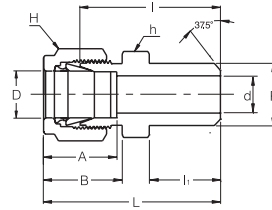

### Connects Fractional Tubes To Pipe

Part No.	Tube O.D. D (inch)	Male Pipe Size P		d Min	Width Across Flat		A	B	I	li	L
		Nom.	O.D.		h (inch)	H (inch)					
SPWC - 2 - 2P	1/8	1/8	10.30	2.28	7/16	7/16	12.70	15.24	23.87	9.65	30.48
SPWC - 3 - 2P	3/16	1/8	10.30	3.04	7/16	1/2	13.71	16.00	24.63	9.65	31.24
SPWC - 4 - 2P	1/4	1/8	10.30	4.82	1/2	9/16	15.24	17.78	25.40	9.65	32.76
SPWC - 4 - 4P	1/4	1/4	13.70	4.82	9/16	9/16	15.24	17.78	30.48	14.22	37.84
SPWC - 5 - 2P	5/16	1/8	10.30	5.08	9/16	5/8	16.25	18.54	26.67	9.65	34.03
SPWC - 5 - 4P	5/16	1/4	13.70	6.35	9/16	5/8	16.25	18.54	31.24	14.22	38.60
SPWC - 6 - 4P	3/8	1/4	13.70	7.11	5/8	11/16	16.76	19.30	32.51	14.22	39.87
SPWC - 6 - 6P	3/8	3/8	17.10	7.11	11/16	11/16	16.76	19.30	32.51	14.22	39.87
SPWC - 6 - 8P	3/8	1/2	21.30	7.11	7/8	11/16	16.76	19.30	38.86	19.05	46.22
SPWC - 8 - 6P	1/2	3/8	17.10	10.41	13/16	7/8	22.86	21.84	33.27	14.22	43.43
SPWC - 8 - 8P	1/2	1/2	21.30	10.41	7/8	7/8	22.86	21.84	38.86	19.05	49.02
SPWC - 8 - 12P	1/2	3/4	26.67	10.41	1-1/16	7/8	22.86	21.84	40.38	19.05	50.54
SPWC - 10 - 8P	5/8	1/2	21.30	12.70	15/16	1	24.38	21.84	38.86	19.05	49.02
SPWC - 12 - 12P	3/4	3/4	26.67	15.74	1-1/16	1-1/8	24.38	21.84	40.38	19.05	50.54
SPWC - 16 - 16P	1	1	33.40	22.35	1-3/8	1-1/2	31.24	26.41	50.03	23.87	62.23

### Connects Metric Tubes To Pipe

Part No.	Tube O.D. D	Male Pipe Size P		d Min	Width Across Flat		A	B	I	li	L
		Nom.	O.D.		h	H					
SPWC - 3M - 2P	3	1/8	10.3	2.4	12	12	12.9	15.3	23.9	9.7	30.5
SPWC - 4M - 2P	4	1/8	10.3	2.4	12	12	13.7	16.1	24.6	9.7	31.2
SPWC - 6M - 2P	6	1/8	10.3	4.8	14	14	15.3	17.7	25.4	9.7	32.8
SPWC - 6M - 4P	6	1/4	13.7	4.8	14	14	15.3	17.7	30.5	14.2	37.9
SPWC - 8M - 2P	8	1/8	10.3	5.1	15	16	16.2	18.6	26.7	9.7	34.2
SPWC - 8M - 4P	8	1/4	13.7	6.4	15	16	16.2	18.6	31.2	14.2	38.7
SPWC - 8M - 8P	8	1/2	21.3	6.4	22	16	16.2	18.6	38.1	19.0	45.6
SPWC - 10M - 4P	10	1/4	13.7	7.1	18	19	17.2	19.5	33.3	14.2	40.9
SPWC - 10M - 6P	10	3/8	17.1	7.9	18	19	17.2	19.5	33.3	14.2	40.9
SPWC - 10M - 8P	10	1/2	21.3	7.9	22	19	17.2	19.5	38.9	19.0	46.5
SPWC - 12M - 4P	12	1/4	13.7	7.1	22	22	22.8	22.0	33.3	14.2	43.4
SPWC - 12M - 6P	12	3/8	17.1	9.5	22	22	22.8	22.0	33.3	14.2	43.4
SPWC - 12M - 8P	12	1/2	21.3	9.5	22	22	22.8	22.0	38.9	19.0	49.0
SPWC - 15M - 8P	15	1/2	21.3	11.9	24	25	24.4	22.0	38.9	19.0	49.0
SPWC - 16M - 8P	16	1/2	21.3	12.7	24	25	24.4	22.0	38.9	19.0	49.0
SPWC - 18M - 8P	18	1/2	21.3	13.5	27	30	24.4	22.0	40.4	19.0	50.5

Note : SUPERLOK® weld ends are constructed per schedule 80 wall thickness or greater. Weld End: ANSI B31.1 and B31.3

### Weld end SUPERLOK® Usage Information:

- Remove nut and ferrules from body to protect them from the weld heat.
- Protect the threads and seat of the fitting body during welding.
- Correct weld procedure is required during and after welding. Suitable heat treatment must be applied in accordance with industry standard.

• All dimensions in millimeters unless specified as "inch". Dimension are for reference only, subject to change.

## SMPWE

### Male Pipe Weld Elbow

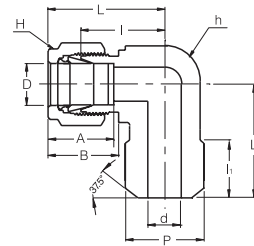

#### Connects Fractional Tubes To Pipe

Part No.	Tube O.D. D (inch)	Pipe Size (P)		d Min	Width Across Flat		A	B	I	I <sub>1</sub>	L	L <sub>1</sub>
		Nom.	O.D.		h (inch)	H (inch)						
SMPWE - 4 - 4P	1/4	1/4	13.70	4.82	1/2	9/16	15.24	17.78	19.55	14.22	26.90	23.37
SMPWE - 6 - 4P	3/8	1/4	13.70	7.11	5/8	11/16	16.76	19.30	23.11	14.22	30.48	25.40
SMPWE - 8 - 8P	1/2	1/2	21.30	10.41	13/16	7/8	22.86	21.84	25.90	19.05	36.06	33.02

## SSWC

### Tube Socket Weld Connector

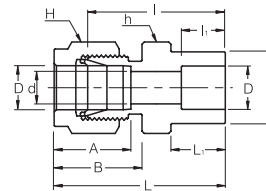

#### Connects Fractional Tubes

Part No.	Tube O.D. D (inch)	d Min	P	Width Across Flat		A	B	I	I <sub>1</sub>	L	L <sub>1</sub>
				h (inch)	H (inch)						
SSWC - 2	1/8	2.28	7.87	7/16	7/16	12.70	15.24	22.35	6.35	28.95	8.63
SSWC - 4	1/4	4.82	11.17	1/2	9/16	15.24	17.78	26.16	7.87	33.52	10.41
SSWC - 6	3/8	7.11	15.74	5/8	11/16	16.76	19.30	30.22	9.65	37.59	11.93
SSWC - 8	1/2	10.41	19.05	13/16	7/8	22.86	21.84	30.98	12.70	41.14	11.93
SSWC - 12	3/4	15.74	26.67	1-1/16	1-1/8	24.38	21.84	33.27	14.22	43.43	11.93
SSWC - 16	1	22.35	33.27	1-3/8	1-1/2	31.24	26.41	40.38	19.05	52.57	14.22

## SSWE

### Tube Socket Weld Elbow

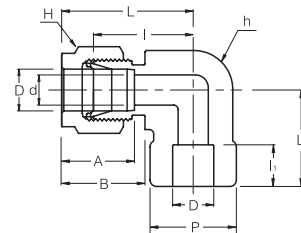

#### Connects Fractional Tubes

Part No.	Tube O.D. D (inch)	d Min	P	Width Across Flat		A	B	I	I <sub>1</sub>	L	L <sub>1</sub>
				h (inch)	H (inch)						
SSWE - 4	1/4	4.82	12.70	1/2	9/16	15.24	17.78	19.55	7.87	26.92	19.55
SSWE - 6	3/8	7.11	15.75	5/8	11/16	16.76	19.30	23.11	9.65	30.48	23.11
SSWE - 8	1/2	10.41	20.57	13/16	7/8	22.86	21.84	25.90	12.70	36.06	25.90
SSWE - 12	3/4	15.74	26.92	1-1/16	1-1/8	24.38	21.84	29.71	14.22	39.87	29.71
SSWE - 16	1	22.35	35.05	1-3/8	1-1/2	31.24	26.41	36.83	19.05	49.02	36.83

\* All dimensions in millimeters unless specified as "inch". Dimension are for reference only, subject to change

## SP Plug

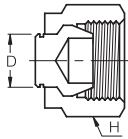

Plug provides plugging fitting port

Installation instruction

1. With wrench, 1/4 turn from finger-tight position. (1/8 turn for 1/8", 3/16", 2, 3, 4 size plug)
2. Remove nut and ferrules from body

## Fractional

Part No.	Tube O.D. D (inch)	Width Across Flat H (inch)	Part No.	Tube O.D. D (inch)	Width Across Flat H (inch)
SP - 2	1/8	7/16	SP - 8	1/2	7/8
SP - 3	3/16	1/2	SP - 10	5/8	1
SP - 4	1/4	9/16	SP - 12	3/4	1-1/8
SP - 5	5/16	5/8	SP - 14	7/8	1-1/4
SP - 6	3/8	11/16	SP - 16	1	1-1/2

Plugs Unused port of Metric **SUPERLOK**® fittings

## Metric

Part No.	Tube O.D. D (inch)	Width Across Flat H	Part No.	Tube O.D. D (inch)	Width Across Flat H
SP - 2M	2	12	SP - 15M	15	25
SP - 3M	3	12	SP - 16M	16	25
SP - 4M	4	12	SP - 18M	18	30
SP - 6M	6	14	SP - 20M	20	32
SP - 8M	8	16	SP - 22M	22	32
SP - 10M	10	19	SP - 25M	25	38
SP - 12M	12	22			

Plugs Unused port of Fractional **SUPERLOK**® fittings

## SC Cap

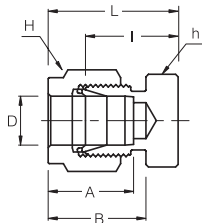

Installation instruction

1. With wrench, 1-1/4 turn from finger-tight position. (3/4 turn for 1/8", 3/16", 3mm, 4mm)
2. Insert tube end into cap

## Connects Caps End of Fractional Tubes

Part No.	Tube O.D. D (inch)	Width Across Flat		A	B	I	L
		h (inch)	H (inch)				
SC - 1	1/16	5/16	5/16	8.63	10.92	11.20	14.98
SC - 2	1/8	7/16	7/16	12.70	15.24	13.46	20.06
SC - 3	3/16	7/16	1/2	13.71	16.00	14.73	21.33
SC - 4	1/4	1/2	9/16	15.24	17.78	16.00	23.36
SC - 5	5/16	9/16	5/8	16.25	18.54	17.01	24.38
SC - 6	3/8	5/8	11/16	16.76	19.30	18.28	25.65
SC - 8	1/2	13/16	7/8	22.86	21.84	19.05	29.21
SC - 10	5/8	15/16	1	24.38	21.84	19.81	29.97
SC - 12	3/4	1-1/16	1-1/8	24.38	21.84	23.33	33.49
SC - 14	7/8	1-3/16	1-1/4	25.90	21.84	23.87	34.03
SC - 16	1	1-3/8	1-1/2	31.24	26.41	26.16	38.35

## Connects Metric Tubes

Part No.	Tube O.D. D	Width Across Flat		A	B	I	L	Part No.	Tube O.D. D	Width Across Flat		A	B	I	L
		h	H							h	H				
SC - 2M	2	12	12	12.9	15.3	13.5	20.1	SC - 15M	15	24	25	24.4	22.0	19.8	29.9
SC - 3M	3	12	12	12.9	15.3	13.5	20.1	SC - 16M	16	24	25	24.4	22.0	19.8	29.9
SC - 4M	4	12	12	13.7	16.1	14.7	21.3	SC - 18M	18	27	30	24.4	22.0	21.3	31.4
SC - 6M	6	14	14	15.3	17.7	15.7	23.1	SC - 20M	20	30	32	26.0	22.0	23.9	34.0
SC - 8M	8	15	16	16.2	18.6	17.0	24.5	SC - 22M	22	30	32	26.0	22.0	23.9	34.0
SC - 10M	10	18	19	17.2	19.5	19.0	26.6	SC - 25M	25	35	38	31.3	26.5	26.2	38.5
SC - 12M	12	22	22	22.8	22.0	19.0	29.1								

## SN Nut

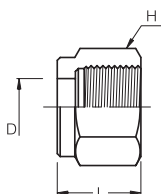

### Fractional

Part No.	Tube O.D. D (inch)	Width Across Flat H (inch)	L	Part No.	Tube O.D. D (inch)	Width Across Flat H (inch)	L
SN - 1	1/16	5/16	7.90	SN - 8	1/2	7/8	17.52
SN - 2	1/8	7/16	11.93	SN - 10	5/8	1	17.52
SN - 3	3/16	1/2	11.93	SN - 12	3/4	1-1/8	17.52
SN - 4	1/4	9/16	12.70	SN - 14	7/8	1-1/4	17.52
SN - 5	5/16	5/8	13.46	SN - 16	1	1-1/2	20.6
SN - 6	3/8	11/16	14.22				

### Metric

Part No.	Tube O.D. D	Width Across Flat H	L	Part No.	Tube O.D. D	Width Across Flat H	L
SN - 2M	2	12	11.9	SN - 14M	14	25	17.4
SN - 3M	3	12	11.9	SN - 15M	15	25	17.4
SN - 4M	4	12	11.9	SN - 16M	16	25	17.4
SN - 6M	6	14	12.7	SN - 18M	18	30	17.4
SN - 8M	8	16	13.5	SN - 20M	20	32	17.4
SN - 10M	10	19	15.1	SN - 22M	22	32	17.4
SN - 12M	12	22	17.4	SN - 25M	25	38	20.6

## SFF Front Ferrule

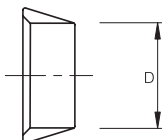

### Fractional

Part No.	Tube O.D. D (inch)	Part No.	Tube O.D. D (inch)
SFF - 1	1/16	SFF - 8	1/2
SFF - 2	1/8	SFF - 10	5/8
SFF - 3	3/16	SFF - 12	3/4
SFF - 4	1/4	SFF - 14	7/8
SFF - 5	5/16	SFF - 16	1
SFF - 6	3/8		

### Metric

Part No.	Tube O.D. D	Part No.	Tube O.D. D
SFF - 2M	2	SFF - 14M	14
SFF - 3M	3	SFF - 15M	15
SFF - 4M	4	SFF - 16M	16
SFF - 6M	6	SFF - 18M	18
SFF - 8M	8	SFF - 20M	20
SFF - 10M	10	SFF - 22M	22
SFF - 12M	12	SFF - 25M	25

## SBF Back Ferrule

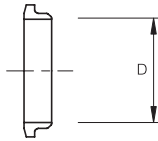

### Fractional

Part No.	Tube O.D. D (inch)	Part No.	Tube O.D. D (inch)	Part No.	Tube O.D. D (inch)
SBF - 1	1/16	SBF - 5	5/16	SBF - 12	3/4
SBF - 2	1/8	SBF - 6	3/8	SBF - 14	7/8
SBF - 3	3/16	SBF - 8	1/2	SBF - 16	1
SBF - 4	1/4	SBF - 10	5/8		

### Metric

Part No.	Tube O.D. D (inch)	Part No.	Tube O.D. D (inch)	Part No.	Tube O.D. D (inch)
SBF - 2M	2	SBF - 10M	10	SBF - 18M	18
SBF - 3M	3	SBF - 12M	12	SBF - 20M	20
SBF - 4M	4	SBF - 14M	14	SBF - 22M	22
SBF - 6M	6	SBF - 15M	15	SBF - 25M	25
SBF - 8M	8	SBF - 16M	16		

## SFS Ferrule Set



### Fractional

Part No.	Tube O.D. D (inch)	Part No.	Tube O.D. D (inch)	Part No.	Tube O.D. D (inch)
SFS - 1	1/16	SFS - 5	5/16	SFS - 12	3/4
SFS - 2	1/8	SFS - 6	3/8	SFS - 14	7/8
SFS - 3	3/16	SFS - 8	1/2	SFS - 16	1
SFS - 4	1/4	SFS - 10	5/8		

### Metric

Part No.	Tube O.D. D (inch)	Part No.	Tube O.D. D (inch)	Part No.	Tube O.D. D (inch)
SFS - 2M	2	SFS - 10M	10	SFS - 20M	20
SFS - 3M	3	SFS - 12M	12	SFS - 22M	22
SFS - 4M	4	SFS - 15M	15	SFS - 25M	25
SFS - 6M	6	SFS - 16M	16		
SFS - 8M	8	SFS - 18M	18		

## SI Insert

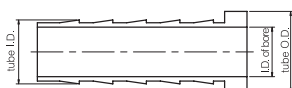
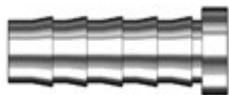

### Fractional

Part No.	Tube O.D. D (inch)	Tube I.D. (inch)	I.D. of Bore	Part No.	Tube O.D. D (inch)	Tube I.D. (inch)	I.D. of Bore
SI - 3 - 2	3/16	1/8	2.28	SI 8 - 4	1/2	1/4	4.82
SI - 4 - 2	1/4	1/8	2.28	SI 8 - 6	1/2	3/8	7.87
SI - 4 - 3	1/4	3/16	3.55	SI 10 - 6	5/8	3/8	7.87
SI - 5 - 2	5/16	1/8	2.28	SI 10 - 8	5/8	1/2	11.17
SI - 5 - 3	5/16	3/16	3.04	SI 12 - 8	3/4	1/2	11.17
SI - 5 - 4	5/16	1/4	4.82	SI 12 - 10	3/4	5/8	14.22
SI - 6 - 3	3/8	3/16	3.04	SI 16 - 12	1	3/4	17.52
SI - 6 - 4	3/8	1/4	4.82				

\* All dimensions in millimeters unless specified as "inch". Dimension are for reference only, subject to change

## SBHR Bulkhead Retainer

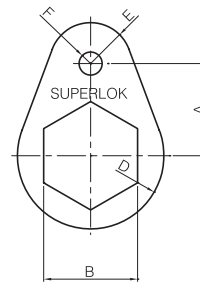

Part No.	A (inch)	B (inch)	C (inch)	D Dia (inch)	E Dia (inch)	F Dia (inch)
SBHR - 1	3/8	5/16	1/8	5/16	5/32	5/32
SBHR - 2	1/2	1/2	1/8	13/32	7/32	5/32
SBHR - 3	9/16	9/16	1/8	15/32	1/4	5/32
SBHR - 4 <sup>②</sup>	5/8	5/8	1/8	1/2	9/32	5/32
SBHR - 5	1/16	11/16	1/8	9/16	5/16	5/32
SBHR - 6	3/4	3/4	1/8	5/8	11/32	5/32
SBHR - 8 <sup>③</sup>	15/16	15/16	1/8	3/4	13/32	7/32
SBHR - 10 <sup>④</sup>	1	1-1/16	1/8	13/16	13/32	7/32
SBHR - 12 <sup>⑤</sup>	1-1/16	1-3/16	1/8	29/32	15/32	7/32
SBHR - 14	1-1/8	1-5/16	1/8	1-1/32	17/32	7/32
SBHR - 16	1-9/32	1-5/8	1/8	1-5/32	9/16	7/32
SBHR - 8M	11/16	18 mm	1/8	9/16	5/16	5/32
SBHR - 10M	15/16	22 mm	1/8	3/4	13/32	7/32

- ① Can be used with 3mm and 4mm bulkheads
- ② Can be used with 6mm bulkheads
- ③ Can be used with 12mm bulkheads
- ④ Can be used with 15mm and 16mm bulkheads
- ⑤ Can be used with 18mm bulkheads

## SVP Vent Protector

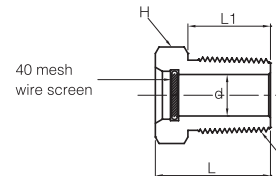

Part No.	T (NPT)	L	L1	d	H (inch)
SVP - 4N	1/4	19.81	14.22	7.11	9/16
SVP - 6N	3/8	20.57	14.22	10.41	11/16
SVP - 8N	1/2	26.16	19.05	12.70	7/8
SVP - 12N	3/4	26.92	19.05	18.29	1-1/16

\* ISO Tapered Threads are available upon request